



Document Solutions



Document Solutions

> PRINT > COPY > SCAN

ECOSYS M6035cidn

> PRINT > COPY > SCAN > FAX

ECOSYS M6535cidn

FIRST STEPS QUICK GUIDE



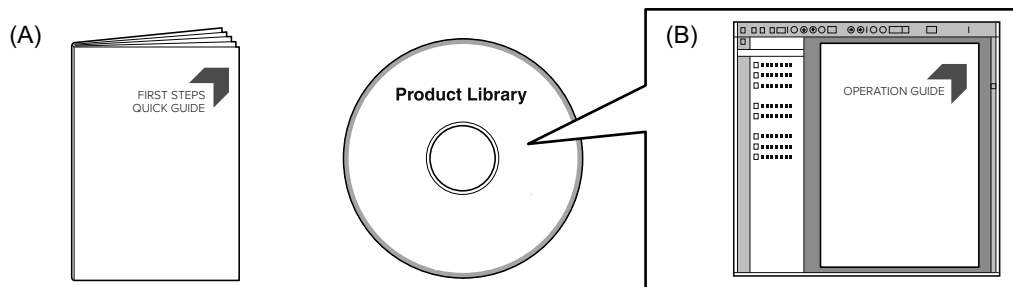

- EN** This guide (A) only explains the basic operations of the machine.
For other information, see Operation Guide (B) on the Product Library disc.
- CA** En aquesta guia (A) només es descriuen les operacions bàsiques de la màquina. Per obtenir més informació, consulteu la Guia de Funcionament (B) al disc Biblioteca del producte (Product Library).
- CS** Tento průvodce (A) vysvětluje pouze základní obsluhu zařízení.
Bližší informace naleznete v Návodu k obsluze (B) na disku Product Library.
- DA** Denne vejledning (A) forklarer kun de grundlæggende funktioner af maskinen.
Andre oplysninger findes i Betjeningsvejledning (B) på Product Library disken.
- DE** Dieser Leitfaden (A) erläutert nur die grundlegende Bedienung des Geräts.
Für weitere Informationen, siehe Bedienungsanleitung (B) in der Product Library auf dem Datenträger.
- EL** Οι παρούσες οδηγίες (A) επεξηγούν μόνο τις βασικές λειτουργίες του μηχανήματος.
Για άλλες πληροφορίες, ανατρέξτε στις Οδηγίες χρήσης (B) στο δίσκο Product Library.
- ES** En esta guía (A) solo se explican los procedimientos básicos de la máquina.
Para obtener otra información, consulte la Guía de uso (B) en el disco Product Library.
- FI** Tässä oppaassa (A) kuvataan vain laitteen perustoiminnot.
Katso tarkemmat tiedot Product Library -levyn Käyttöopas (B).
- FR** Ce guide (A) explique uniquement les opérations de base de la machine.
Pour toute autre information, se reporter au Manuel d'utilisation (B) sur le disque Product Library.
- HU** Ez az útmutató (A) csak a készülék alapvető működését ismerteti.
Bővebb információért lásd a Használati útmutatót (B) a Product Library lemezen.
- IT** Questa guida (A) descrive solo le funzioni base del dispositivo.
Per ulteriori informazioni, vedere la Guida alle funzioni (B) sul disco Product Library.
- NL** In deze handleiding (A) worden alleen de basisfuncties van de machine beschreven.
Voor meer informatie, raadpleeg de gebruikershandleiding (B) op de Product Library schijf.
- NO** Denne guide (A) forklarer bare den grunnleggende bruken av maskinen.
For annen informasjon, se Operatørhåndbok (B) i Product Library platen.

PL Niniejszy podręcznik (A) objaśnia jedynie podstawowe sposoby używania urządzenia.
Więcej informacji można znaleźć w Podręczniku Obsługi (B) lub na dysku Product Library.

PT-BR Este guia (A) somente explica as operações básicas da máquina.
Para obter outras informações, consulte o Guia de Operação (B) no disco Product Library.

PT-PT Este guia (A) explica apenas as operações básicas da máquina.
Para obter mais informações, consulte o Guia de Operação (B) no disco Product Library.

RO Acest ghid (A) explică doar operațiunile de bază ale aparatului.
Pentru alte informații, consultați Ghidul de Operare (B) de pe discul Product Library.

RU В данном руководстве (A) описаны только основные операции с устройством.
Дополнительные сведения см. в руководстве по эксплуатации (B) на диске Product Library.

SV I den här guiden (A) förklaras endast maskinens grundfunktioner.
För annan information hänvisas till bruksanvisningen (B) på skivan Product Library.

TR Bu kılavuz (A) sadece makinenin temel işlemlerini açıklar.
Diğer bilgiler için, Product Library diskindeki Çalıştırma Kılavuzuna (B) bakınız.

AR هذا الدليل (A) يشرح فقط عمليات تشغيل الجهاز الأساسية.
لمزيد من المعلومات، راجع دليل التشغيل (B) الموجود على قرص Product Library.

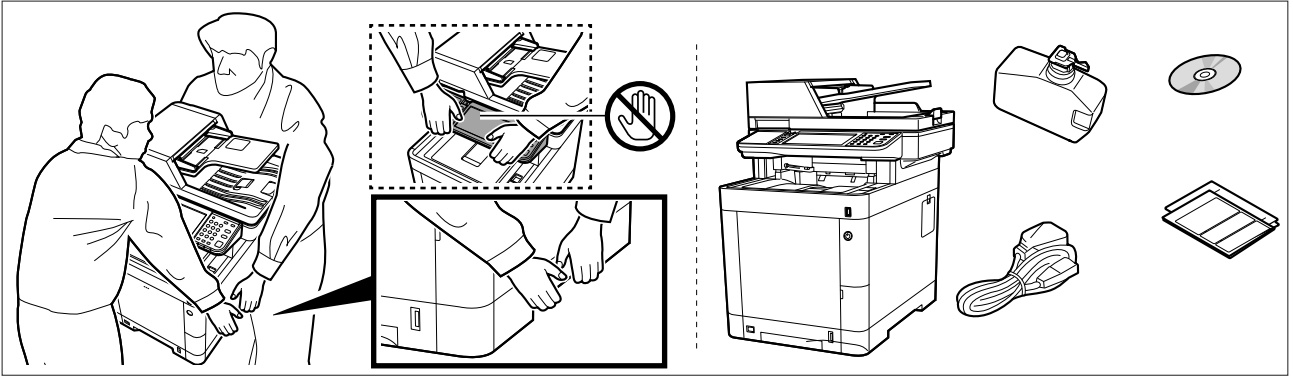

- EN** The included components differ depending on the countries or regions.
- CA** Els components que s'hi inclouen poden variar en funció dels països o de les regions.
- CS** Přiložené součásti se mohou lišit v závislosti na zemích nebo oblastech.
- DA** De medfølgende komponenter varierer afhængigt af land eller region.
- DE** Je nach Land oder Region sind im Lieferumfang andere Komponenten enthalten.
- EL** Τα εξαρτήματα που περιλαμβάνονται ενδέχεται να διαφέρουν ανάλογα με τη χώρα ή την περιοχή.
- ES** Los componentes facilitados varían en función de los países o regiones.
- FI** Pakkaukseen kuuluvat osat vaihtelevat maan ja alueen mukaan.
- FR** Les composants inclus varient en fonction des pays ou régions.
- HU** A mellékelt alkatrészek országtól vagy régiótól függően változók.
- IT** I componenti inclusi sono differenti a seconda del paese o della zona geografica.
- NL** De meegeleverde onderdelen verschillen volgens het land of de regio.
- NO** De medfølgende komponentene varierer avhengig av land eller region.
- PL** Dołączone do urządzenia wyposażenie może różnić się w zależności od kraju lub regionu.
- PT-BR** Os componentes incluídos variam conforme os países ou as regiões.
- PT-PT** Os componentes incluídos variam consoante os países ou regiões.
- RO** Componentele incluse diferă în funcție de țară sau regiune.
- RU** Комплектация компонентами зависит от страны или региона.
- SV** De medföljande komponenterna varierar i olika länder och regioner.
- TR** Ürünle birlikte verilen parçalar ülkeye veya bölgeye göre değişir.
- AR** تختلف المكونات المضمنة باختلاف البلاد أو المناطق.

C Setting up the Toner Container

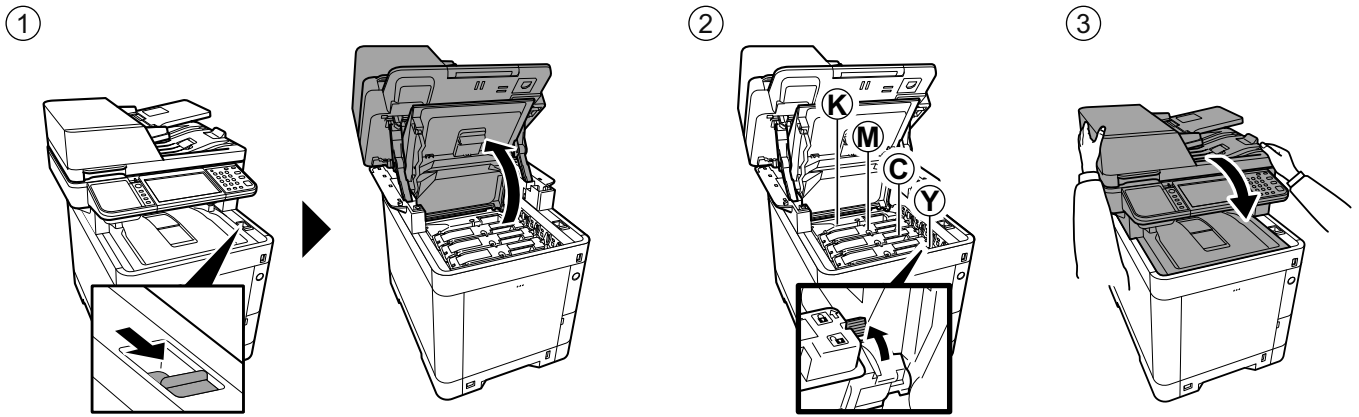

D Connect Cable

Network

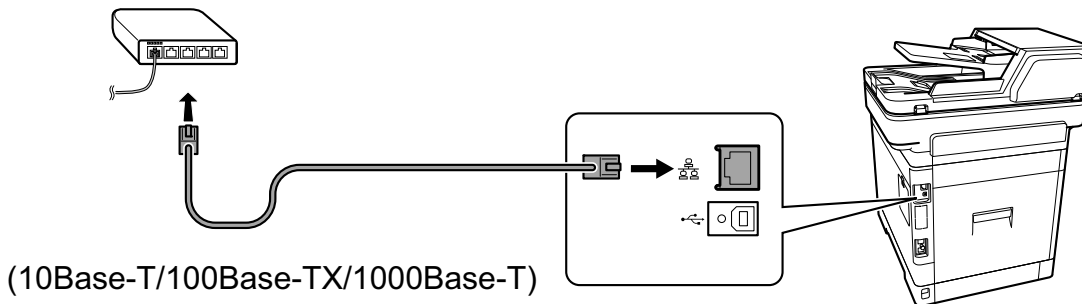

USB

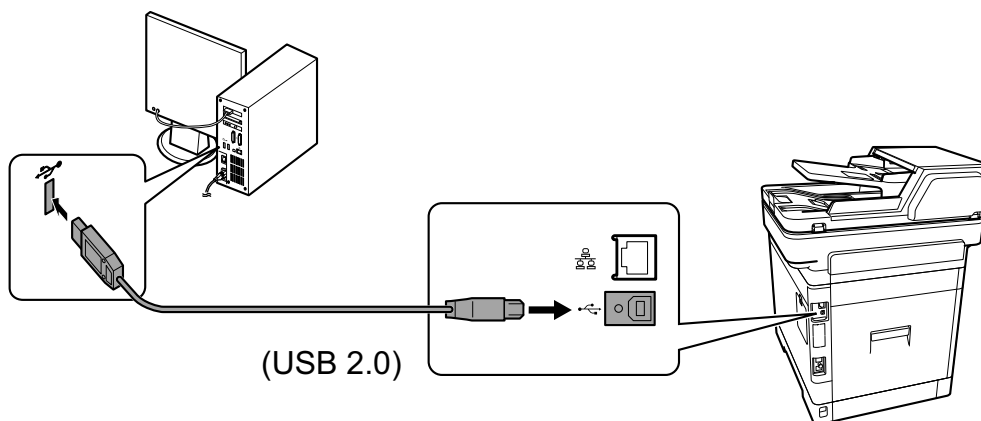

E**Loading Paper**

①

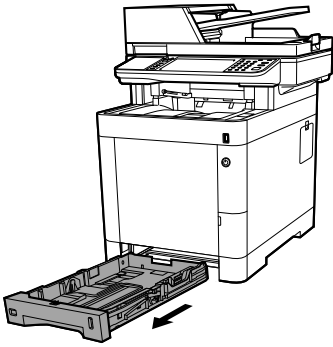

②

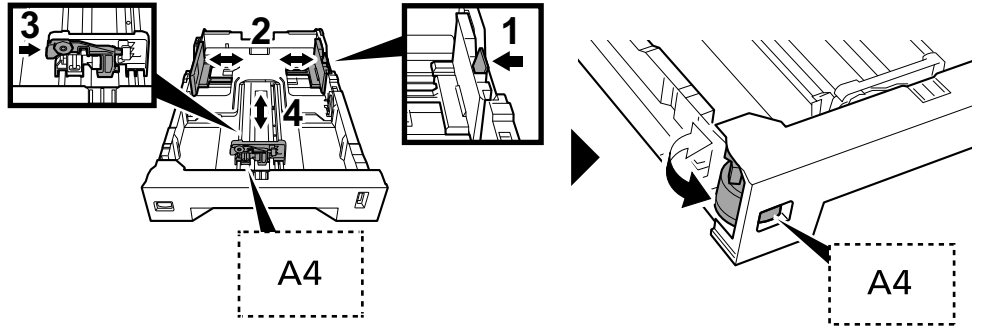

③

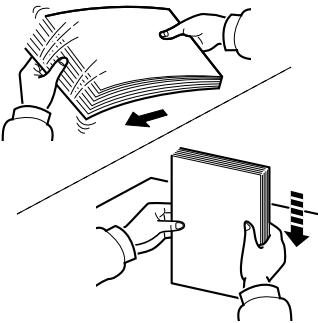

④

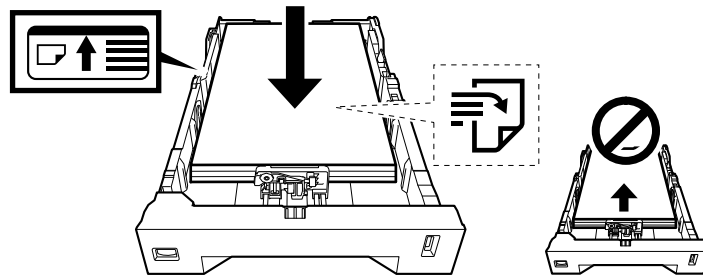

⑤

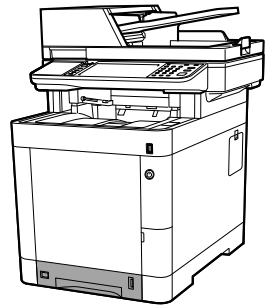
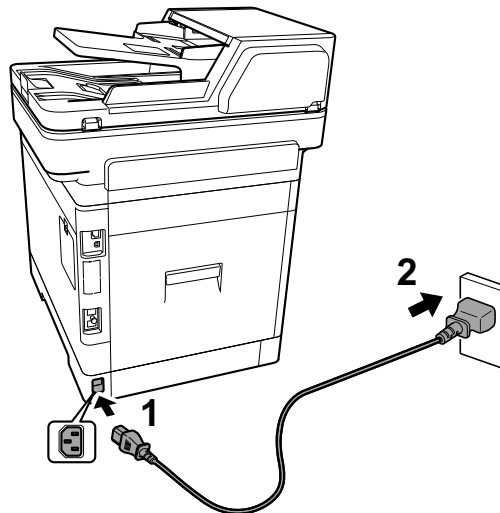
**F****Connect Power Cord**

G Replace Operation Panel Sheet

①

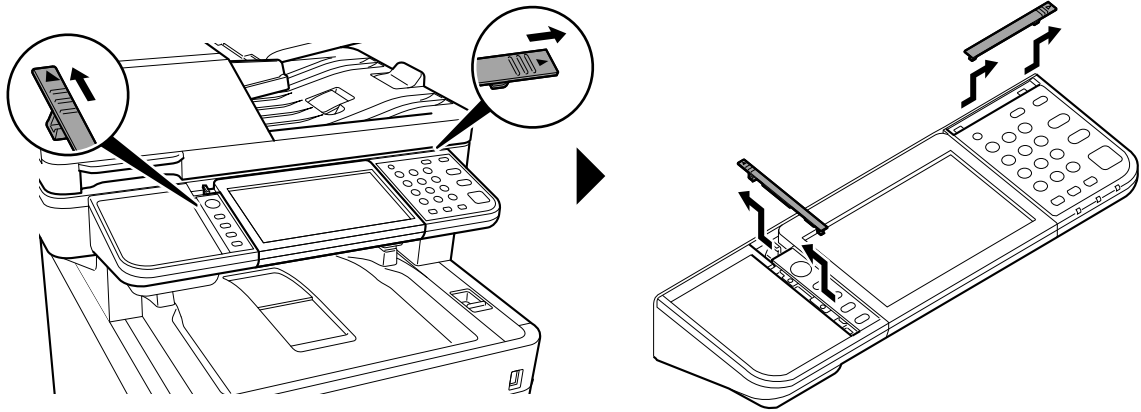

②

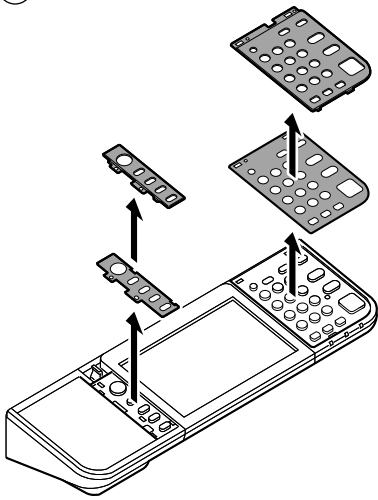

③

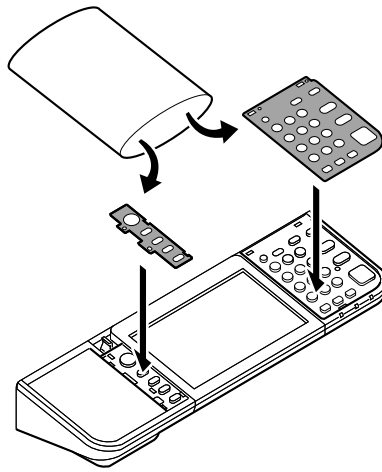

④

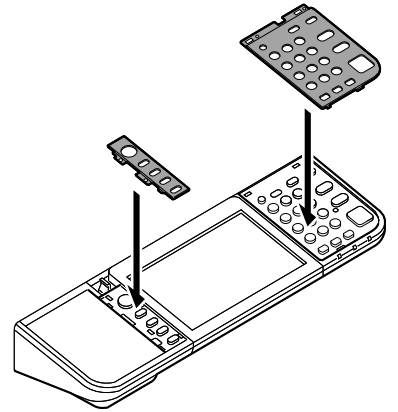

⑤

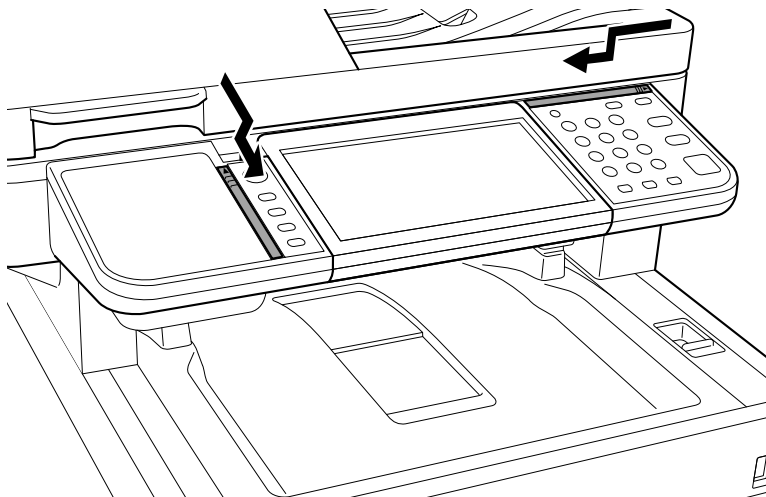

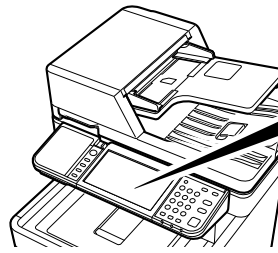
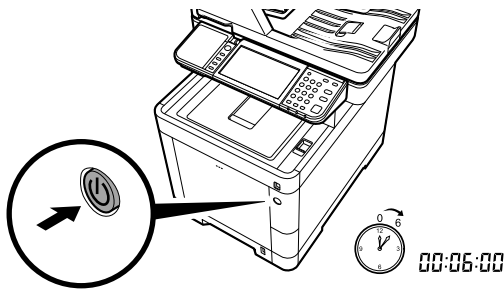

- EN** At the first time when turning on the main power switch, the machine runs Startup Wizard to set the following:
1. Language 2. Date/Time 3. Network
Follow the instructions on the operation panel.
- CA** La primera vegada que premeu el botó d'engegada, el dispositiu iniciarà l'Auxiliar d'inici per configurar els elements següents:
1. Idioma 2. Data/Hora 3. Xarxa
Seguiu les instruccions del tauler d'operacions.
- CS** Při prvním zapnutí hlavního vypínače se na zařízení spustí Průvodce spuštěním, pomocí něhož můžete nastavit tyto položky:
1. Jazyk 2. Datum a čas 3. Síť
Postupujte podle pokynů na provozním panelu.
- DA** Når hovedstrømfafbryderen tændes for første gang kører maskinen Start guiden for at indstille følgende:
1. Sprog 2. Dato/klokkeslæt 3. Netværk
Følg anvisningerne på betjeningspanelet.
- DE** Wenn der Hauptschalter der Maschine das erste Mal angeschaltet wird, führt die Maschine den Startup Wizard aus, um Folgendes einzustellen:
1. Sprache 2. Datum/Zeit 3. Netzwerk
Folgen Sie den Anweisungen auf dem Bedienfeld.
- EL** Μόλις ανοίξετε τον κεντρικό διακόπτη λειτουργίας για πρώτη φορά, το μηχάνημα εκτελεί τον Οδηγό Εκκίνησης για να ρυθμίσει τα εξής:
1. Γλώσσα 2. Ημερομηνία/Ωρα 3. Δίκτυο
Ακολουθήστε τις οδηγίες που εμφανίζονται στον πίνακα λειτουργίας.
- ES** Al encender el interruptor de alimentación principal por primera vez, la máquina ejecutará el Asistente de inicio para configurar lo siguiente:
1. Idioma 2. Fecha/hora 3. Red
Siga las instrucciones del panel de controles.
- FI** Kun kytket virran päälle virtakytkimellä ensimmäisen kerran, laite käynnistää ohjatun aloitustoiminnon seuraavien tietojen asetusta varten:
1. Kieli 2. Pvm./aika 3. Verkko
Noudata käyttöpaneelin ohjeita.
- FR** Lors de la première mise sous tension de l'appareil, l'assistant de démarrage se lance pour régler les paramètres suivants:
1. Langue 2. Date/Heure 3. Réseau
Suivez les instructions sur le panneau de commande.
- HU** A főkapcsolót először bekapcsolva futni kezd az indítási varázsló, mely az alábbi beállításokat teszi lehetővé:
1. Nyelv 2. Dátum/Idő 3. Hálózati
Kövesse a kezelőpultton megjelenő utasításokat.
- IT** Alla prima accensione del sistema, viene eseguita la procedura guidata di avvio per la configurazione delle seguenti voci:
1. Lingua 2. Data/Ora 3. Rete
Attenersi alle istruzioni visualizzate sul pannello comandi.
- NL** Als de hoofdschakelaar voor de eerste keer ingeschakeld wordt, dan start het apparaat de wizard Opstarten op om de volgende instellingen in te stellen:
1. Taal 2. Datum/tijd 3. Netwerk
Volg de instructies op het bedieningspaneel.
- NO** Første gang strømbryteren slås på, starter maskinen Startup Wizard for innstilling av følgende:
1. Språk 2. Dato/klokke 3. Nettverk
Følg veiledningen på betjeningspanelet.
- PL** Przy pierwszym uruchomieniu, po naciśnięciu głównego włącznika zasilania uruchomi się Przewodnik instalacji, który pozwoli ustawić następujące funkcje:
1. Język 2. Data/czas 3. Sieć
Wykonuj instrukcje z panelu operacyjnego.
- PT-BR** Na primeira vez que você liga a chave de energia principal, a máquina executa o Assistente para a Inicialização para definir os seguintes:
1. Idioma 2. Data/hora 3. Rede
Siga as instruções no painel de operação.
- PT-PT** Quando ligar o interruptor de alimentação principal pela primeira vez, a máquina executa o Assistente de Arranque para definir o seguinte:
1. Idioma 2. Data/Hora 3. Rede
Siga as instruções no painel de funcionamento.
- RO** Prima dată când porniți alimentarea cu energie, echipamentul execută Expertul de configurare pentru a seta următoarele:
1. Limbă 2. Dată/Oră 3. Rețea
Urmați instrucțiunile de pe panoul de utilizare.
- RU** При первом включении главного выключателя аппарат запускает мастер начальной настройки для установки следующих параметров:
1. Язык 2. Дата/время 3. Сетевой
Выполните инструкции на панели управления.
- SV** När maskinen startas för första gången med huvudströmbrytaren kör den startguiden för att ställa in följande:
1. Språk 2. Datum/tid 3. Nätverk
Följ instruktionerna som anges på kontrollpanelen.
- TR** Ana güç düğmesi ilk defa açıldığında, cihaz aşağıdakileri ayarlamak için Başlangıç Sihirbazını çalıştırır:
1. Dil 2. Tarih/Saat 3. Ağ
İşletim panosundaki talimatları izleyin.
- AR** عند تشغيل مفتاح الطاقة الرئيسي للمرة الأولى، يقوم الجهاز بتشغيل معالج بدء التشغيل لإعداد ما يلي:
1. اللغة 2. التاريخ/الوقت 3. شبكة
اتبع التعليمات الموجودة على لوحة التشغيل.

Quick Setup Wizard

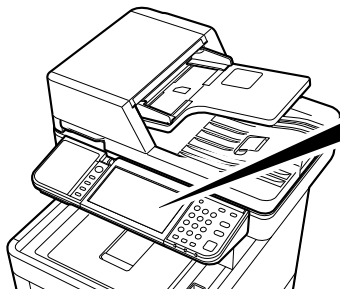

- EN** The machine provides Quick Setup Wizard in System Menu to set the following as necessary:
1. FAX Setup (ECOSYS M6535cidn)
 2. Paper Setup
 3. Energy Saver Setup
 4. Network Setup
- Follow the instructions on the operation panel.
- ES** La máquina dispone de un Asistente de configuración rápida en el Menú Sistema que permite configurar lo siguiente según sea necesario:
1. Configuración de fax (ECOSYS M6535cidn)
 2. Configuración de papel
 3. Configuración de ahorro de energía
 4. Configuración de red
- Siga las instrucciones del panel de controles.
- CA** El dispositiu inclou un Auxiliar de configuració ràpida al Menú del sistema per configurar les opcions següents segons calgui:
1. Configuració del FAX (ECOSYS M6535cidn)
 2. Configuració del paper
 3. Configuració de l'estalvi d'energia
 4. Configuració de xarxa
- Seguiu les instruccions del tauler d'operacions.
- FI** Koneen mukana toimitetaan järjestelmävälirikossa ohjattu pika-asetusohjelma seuraavien asetukseen tarvittaessa:
1. Faksin asennus (ECOSYS M6535cidn)
 2. Paperin asennus
 3. Virransäästön asennus
 4. Verkkoasetus
- Noudata käyttöpaneelin ohjeita.
- FR** La machine fournit un Assistant configuration rapide dans le menu système pour configurer les éléments suivants si nécessaire :
1. Configuration du fax (ECOSYS M6535cidn)
 2. Configuration du papier
 3. Configuration de l'économie d'énergie
 4. Configuration réseau
- Suivez les instructions sur le panneau de commande.
- CS** V systémove nabídce zařizení je k dispozici průvodce rychlým nastavením, pomocí kterého můžete následující nastavit dle potřeby:
1. Žádný (ECOSYS M6535cidn)
 2. Nastavení papíru
 3. Nastavení spořiče energie
 4. Nastavení sítě
- Postupujte podle pokynů na provozním panelu.
- DA** Maskinen tilbyder guide til hurtig opsætning i systemmenuen for at indstille følgende som nødvendigt:
1. Faxopsætning (ECOSYS M6535cidn)
 2. Papiropsætning
 3. Opsætning af energisparetilstand
 4. Netværksopsætning
- Følg anvisningerne på betjeningspanelet.
- HU** A készülék Rendszeremenüjében található Gyorsbeállítás varázsló segítségével az alábbiak állíthatók be:
1. FAX beállítás (ECOSYS M6535cidn)
 2. Papír beállítás
 3. Energiatakarékosság beállítása
 4. Hálózat beállítása
- Kövesse a kezelőpulton megjelenő utasításokat.
- DE** Das Gerät verfügt im Systemmenü über einen Schnelleinstellung Assistenten, um bei Bedarf folgende Einstellungen vorzunehmen:
1. Fax Einstellung (ECOSYS M6535cidn)
 2. Papier Einstellung
 3. Energie sparen Einstellung
 4. Netzwerk-Einstellungen
- Folgen Sie den Anweisungen auf dem Bedienfeld.
- IT** La macchina offre una Procedura guidata di configurazione rapida nel Menu Sistema per la configurazione delle seguenti voci:
1. Impostazione FAX (ECOSYS M6535cidn)
 2. Impostazione carta
 3. Impostazione modalità di risparmio energia.
 4. Configurazione della rete
- Attenersi alle istruzioni visualizzate sul pannello comandi.
- EL** Το μηχάνημα παρέχει έναν Οδηγό Ταχείας Διαμόρφωσης στο Μενού Συστήματος για τη ρύθμιση των παρακάτω όπως απαιτείται:
1. Ρύθμιση FAX (ECOSYS M6535cidn)
 2. Ρύθμιση Χαρτιού
 3. Ρύθμιση Λειτουργίας Εξοικονόμησης Ενέργειας
 4. Ρυθμίσεις Δικτύου
- Ακολουθήστε τις οδηγίες που εμφανίζονται στον πίνακα λειτουργίας.
- NL** Het apparaat heeft een Versnelde installatie-wizard in het Systeemmenu om het volgende in te stellen:
1. FAX setup (ECOSYS M6535cidn)
 2. Papier setup
 3. Energiebesparing setup
 4. Netwerkkonfiguratie
- Volg de instructies op het bedieningspaneel.

- NO** Maskinen gir en hurtigoppsettveiviser i systemmenyen for å stille inn følgende:
1. Faksoppsett (ECOSYS M6535cidn)
 2. Papiroppsett
 3. Strømsparingoppsett
 4. Nettverksoppsett
- Følg veiledningen på betjeningspanelet.
- RU** В аппарате предусмотрен мастер быстрой установки в системном меню для настройки по мере необходимости следующих параметров:
1. Настройка факса (ECOSYS M6535cidn)
 2. Настройка бумаги
 3. Настройка энергосбережения
 4. Настройка сети
- Выполните инструкции на панели управления.
- PL** W Menu systemu dostępne jest polecenie Kreator szybkiej konfiguracji, które pozwala skonfigurować w razie potrzeby następujące ustawienia:
1. Konfiguracja FAKSU (ECOSYS M6535cidn)
 2. Konfiguracja papieru
 3. Konfiguracja oszczędzania energii
 4. Konfiguracja sieci
- Wykonuj instrukcje z panelu operacyjnego.
- SV** I maskinens systemmeny finns en snabbinstallationsguide för en korrekt inställning av följande:
1. Inställning av fax (ECOSYS M6535cidn)
 2. Inställning av papper
 3. Inställning av energisparläge
 4. Nätverkinst.
- Följ instruktionerna som anges på kontrollpanelen.
- PT-BR** A máquina oferece o Assistente de Configuração Rápida no Menu do Sistema para definir o seguinte, conforme necessário:
1. Configuração de FAX (ECOSYS M6535cidn)
 2. Configuração do papel
 3. Configuração de economia de energia
 4. Configuração de rede
- Siga as instruções no painel de operação.
- TR** Makinede aşağıdakileri gereken şekilde ayarlamak için Sistem Menüünde Hızlı Ayar Sihirbazı mevcuttur:
1. FAKS Ayarlama (ECOSYS M6535cidn)
 2. Kağıt Ayarlama
 3. Enerji Tasarruf Ayarlama
 4. Ağ Kurulumu
- İşletim panosundaki talimatları izleyin.
- PT-PT** A máquina disponibiliza o Assistente de Configuração Rápida no Menu de Sistema para configurar o seguinte, conforme necessidade:
1. Configuração de FAX (ECOSYS M6535cidn)
 2. Configuração de papel
 3. Configuração de Poupança de Energia
 4. Configuração de Rede
- Siga as instruções no painel de funcionamento.
- AR** يوفر الجهاز معالج الإعداد السريع في قائمة النظام لتعيين ما يلي وفقاً لما تقتضيه الضروري:
1. إعداد الفاكس (ECOSYS M6535cidn)
 2. إعداد الورق
 3. إعداد موثر الطاقة
 4. إعداد الشبكة
- اتبع التعليمات الموجودة على لوحة التشغيل.
- RO** Aparatul oferă un Expert de configurare rapidă în meniul de sistem pentru configurarea următoarelor după necesități:
1. Configurare fax (ECOSYS M6535cidn)
 2. Configurare hârtie
 3. Configurare economie energie
 4. Configurare rețea
- Urmați instrucțiunile de pe panoul de utilizare.

1

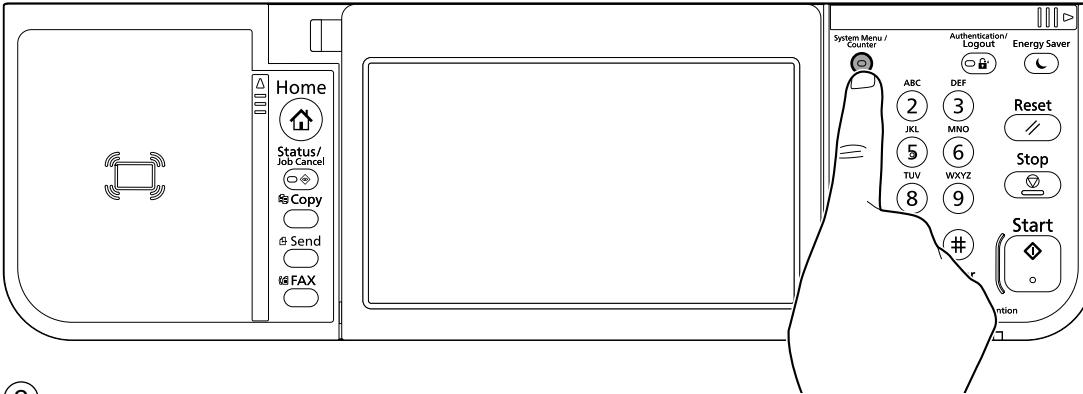

2

EN

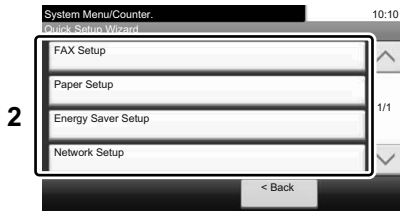
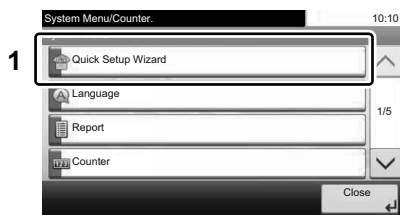

CA

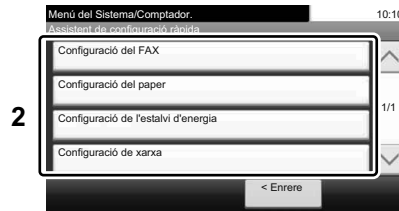
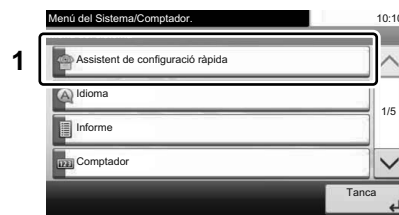

CS

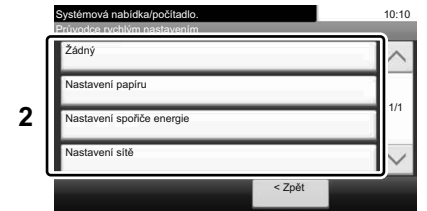

DA

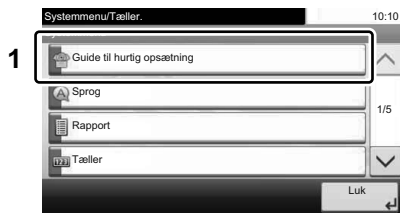

DE

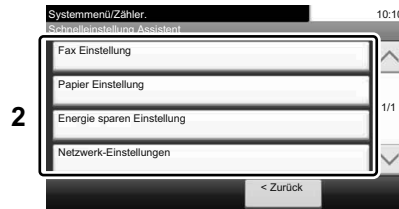
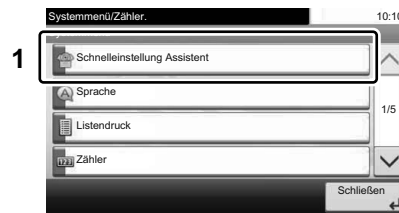

EL

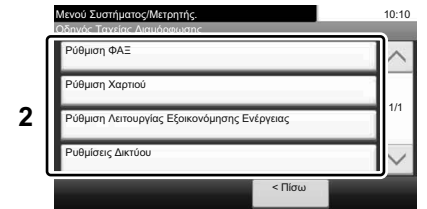
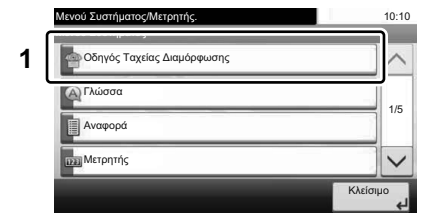

ES

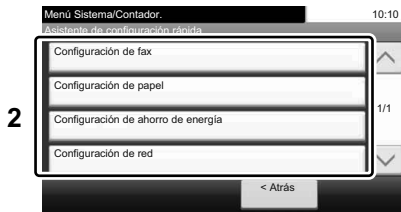
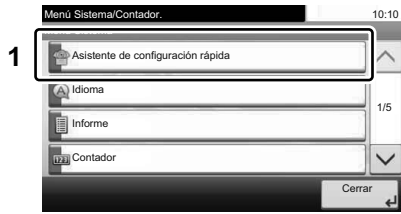

FI

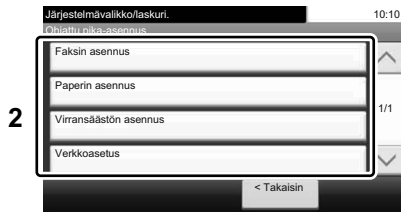
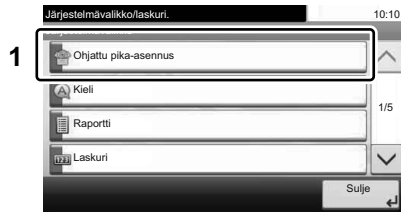

FR

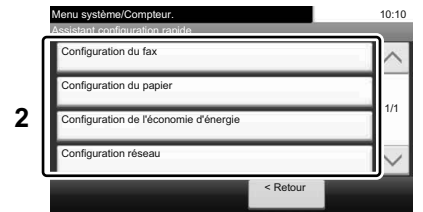
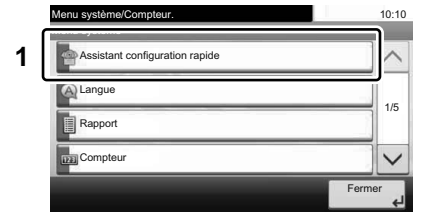

HU

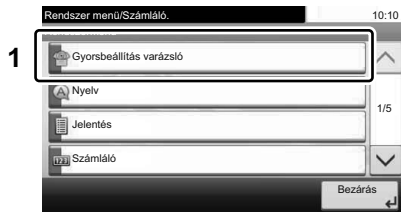

IT

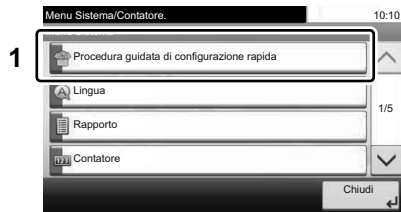

NL

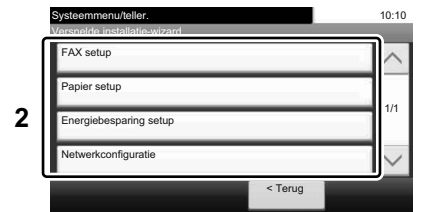
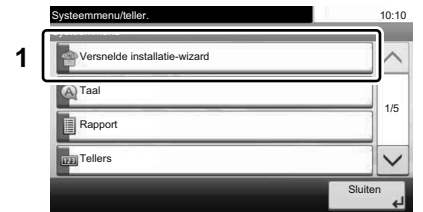

NO



PL

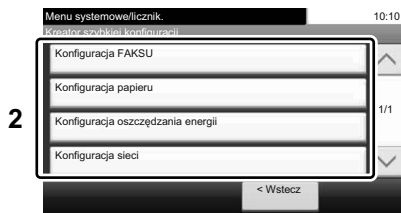

PT-BR

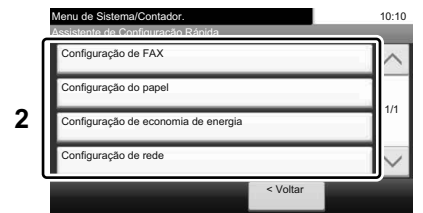
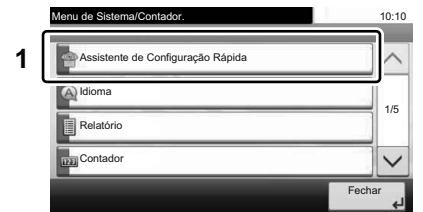

PT-PT

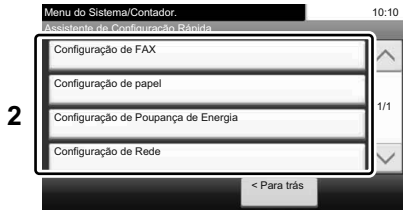
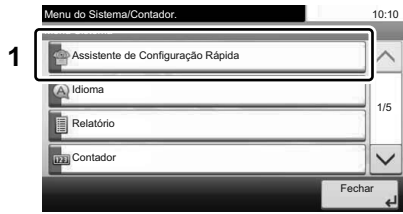

RO

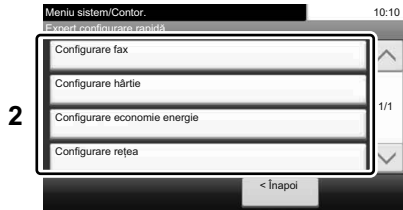
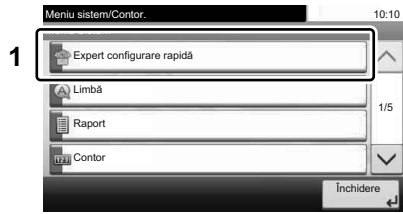

RU

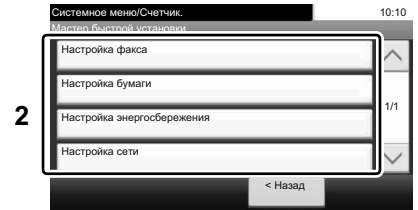
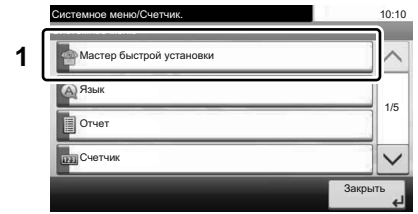

SV

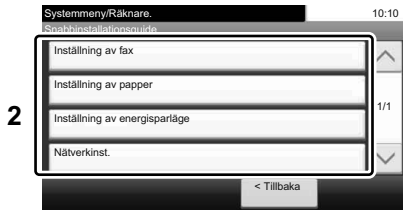
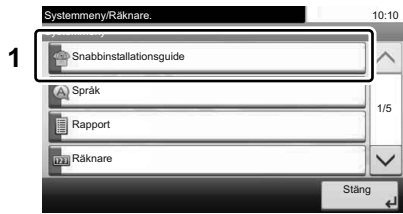

TR



AR



①

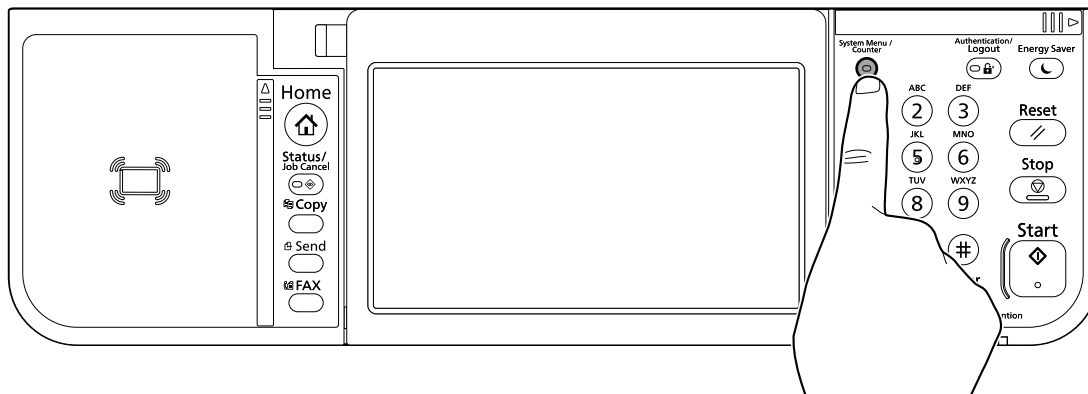

②

EN

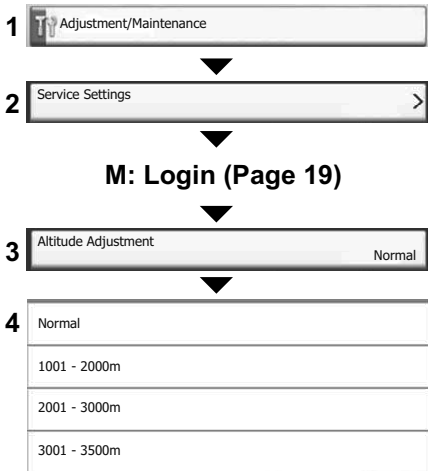

ES

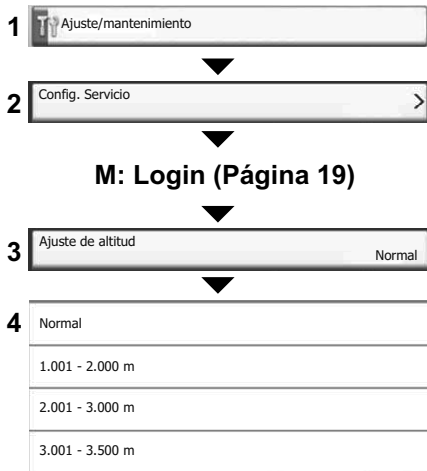

FR

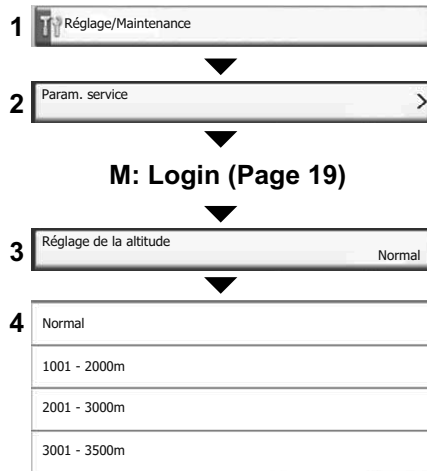

PT-BR

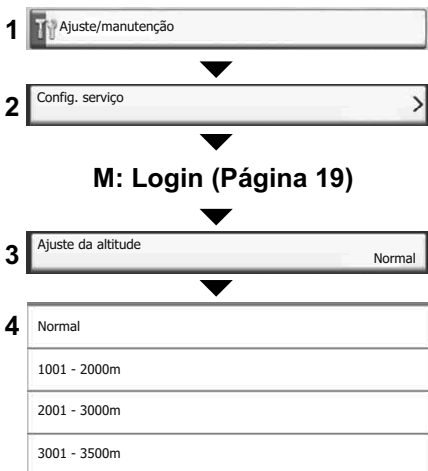

①

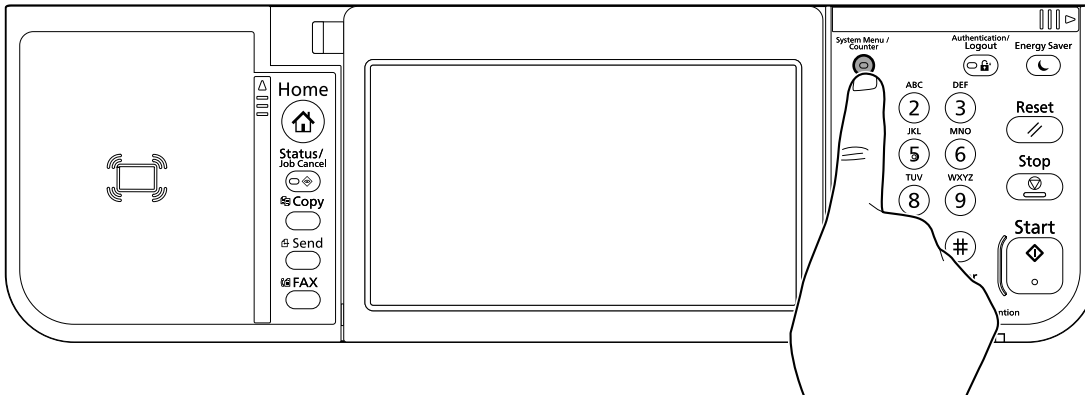

②

EN

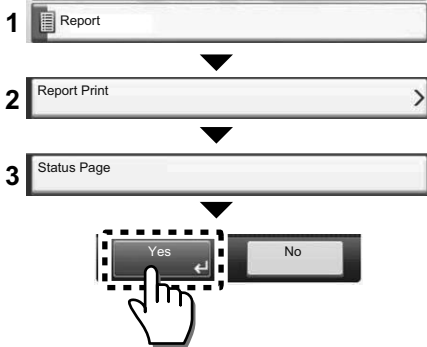

CA

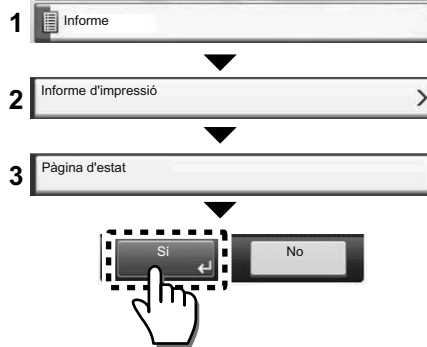

CS



DA

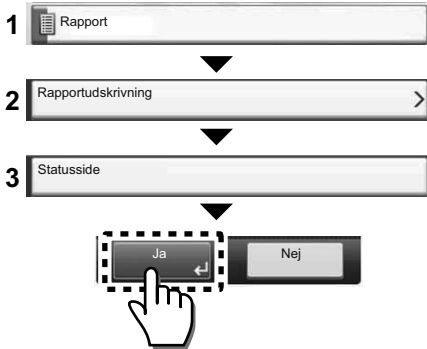

DE

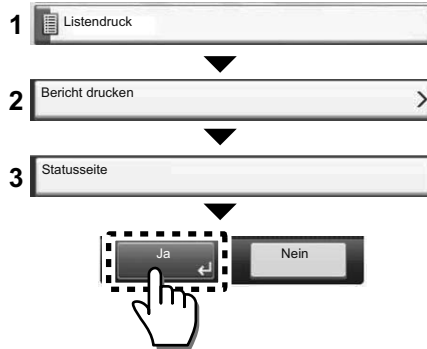

EL



ES

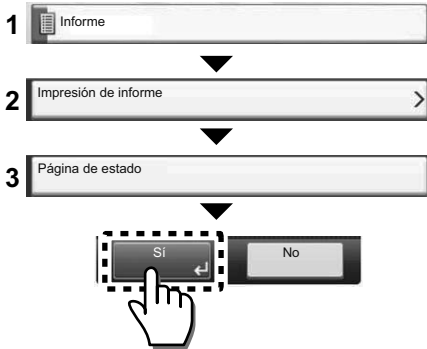

FI

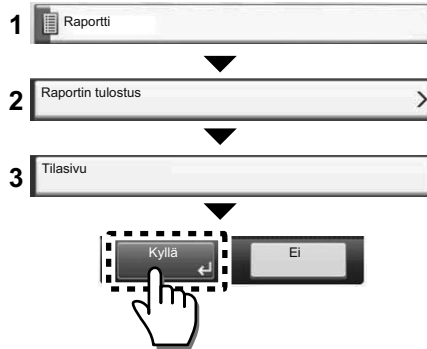

FR

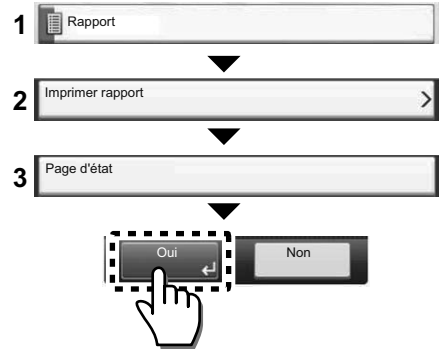

HU

1 Jelentés

2 Jelentés nyomtatása

3 Állapotoldal

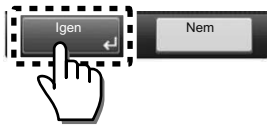

IT

1 Rapporto

2 Stampa rapporto

3 Pagina stato

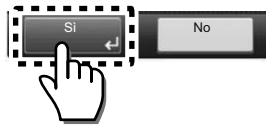

NL

1 Rapport

2 Rapport afdrucken

3 Statuspagina

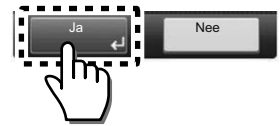

NO

1 Rapport

2 Rapportutskrift

3 Status

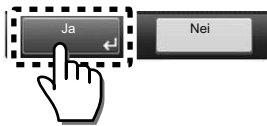

PL

1 Raport

2 Raportuj drukowanie

3 Strona stanu

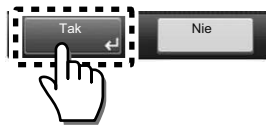

PT-BR

1 Relatório

2 Impressão de relatório

3 Página de status

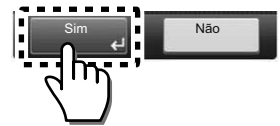

PT-PT

1 Relatório

2 Impressão Relatório

3 Página Estado

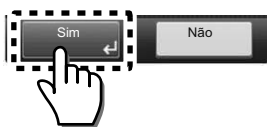

RO

1 Raport

2 Imprimare Raport

3 Pagina Stare

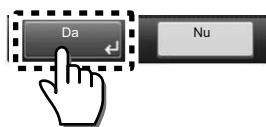

RU

1 Отчет

2 Печать отчета

3 Стр. состояния

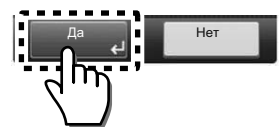

SV

1 Rapport

2 Skriv ut rapport

3 Statussida

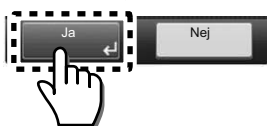

TR

1 Rapor

2 Rapor Yazdırma

3 Durum Sayfası

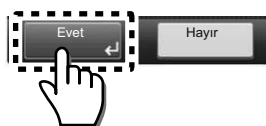

AR

1 تقرير

2 طباعة التقرير

3 صفحة الحالة



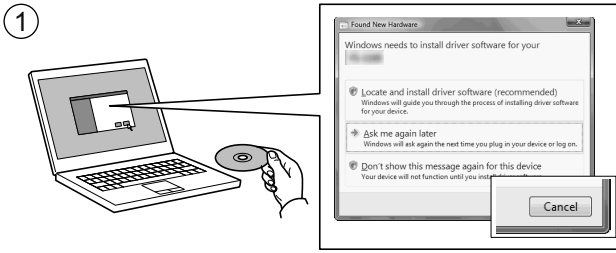

- EN** If Found new Hardware window appears, click Cancel.
- CA** Si es mostra la finestra "Found new Hardware" (S'ha detectat maquinari nou), feu clic a Cancel·la.
- CS** Pokud se zobrazí dialogové okno Nalezen nový hardware, klepněte na tlačítko Storno.
- DA** Vælg Annuller, hvis dialogboksen Der er fundet ny hardware.
- DE** Bitte legen Sie die beiliegende CD ein und folgen Sie den Anweisungen am Bildschirm, falls auf dem Bildschirm die Anzeige 'Neue Hardware gefunden' von Windows erscheint, drücken Sie Abbrechen.
- EL** Αν εμφανιστεί το παράθυρο Εύρεση νέου υλικού, κάντε κλικ στο κουμπί Άκυρο.
- ES** Si aparece la ventana Nuevo hardware encontrado, haga clic en Cancelar.
- FI** Jos näkyyiin tulee Uusi laite löydetty -ikkuna, napsauta Peruuta.
- FR** Si la fenêtre Nouveau matériel détecté s'affiche, cliquez sur Annuler.
- HU** Ha az Új hardver telepítési ablak megjelenik, kattintson a Mégse gombra.
- IT** Se compare la finestra Trovato nuovo hardware, fare clic su Annulla.
- NL** Als het dialoogvenster nieuwe hardware gevonden verschijnt, selecteert u Annuleren.
- NO** Hvis vinduet Ny maskinvare funnet vises, klikk på Avbryt.
- PL** Jeżeli wyświetlone zostanie okno Znaleziono nowy sprzęt, należy kliknąć przycisk Anuluj.
- PT-BR** Se a janela Um novo Hardware foi encontrado aparecer, clique em Cancelar.
- PT-PT** Se a janela Encontrar Novo Hardware aparecer, clique em Cancelar.
- RO** Dacă apare fereastra Found New Hardware, faceți clic pe Cancel.
- RU** Если появляется окно Найдено новое аппаратное обеспечение, щелкните Отменить.
- SV** Om Dialogfönstret visar 'Hittade ny hårdvara' klicka då på Avbryt.
- TR** Yeni Donanım Bulundu penceresi görüntülenirse, İptal'i tıklatın.
- AR** إذا ظهرت نافذة تم العثور على جهاز جديد ، انقر على إلغاء.

2

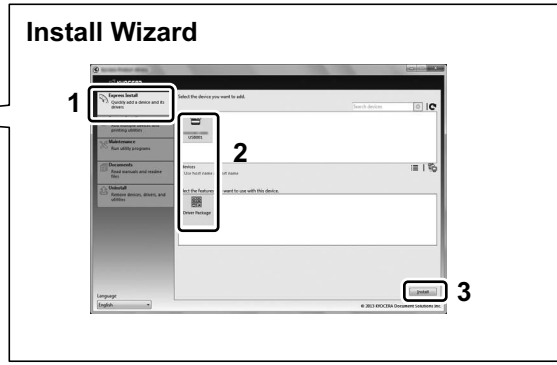
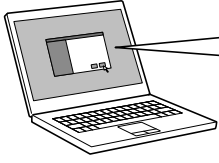

- EN** Follow the instructions in the installation wizard.
- CA** Seguiu les instruccions de l'auxiliar d'instal·lació.
- CS** Řiďte se pokyny v průvodci instalací.
- DA** Følg instruktionerne i installationsguiden.
- DE** Folgen Sie den Anweisungen des Schnelleinstellung Assistenten.
- EL** Ακολουθήστε τις οδηγίες στον οδηγό εγκατάστασης.
- ES** Siga las instrucciones del asistente de instalación.
- FI** Noudata asennusohjelman ohjeita.
- FR** Suivre les instructions de l'assistant d'installation.
- HU** Kövesse a telepítő varázsló utasításait.
- IT** Attenersi alle istruzioni della procedura guidata di installazione.
- NL** Volg de instructies in de installatiewizard.
- NO** Følg instruksjonene i installasjonsveiledningen.
- PL** Postępuj zgodnie z instrukcjami wyświetlanymi w oknie kreatora instalacji.
- PT-BR** Siga as instruções no assistente de instalação.
- PT-PT** Siga as instruções no assistente de instalação.
- RO** Urmați instrucțiunile expertului de instalare.
- RU** Следуйте инструкциям в окне мастера установки.
- SV** Följ anvisningarna i installationsguiden.
- TR** Kurulum sihirbazındaki talimatları izleyiniz.
- AR** اتبع تعليمات معالج التثبيت.

M Login

Enter login user name and password. 10:10

Login User Name Keyboard

Login Password Keyboard

Login

(EN)

Login User Name: 3500

Login Password: 3500

(CA)

Nom d'inici de sessió: 3500

Contrasenya de sessió: 3500

(CS)

Přihl. uživ. jméno: 3500

Přihl. Heslo: 3500

(DA)

Brugernavn til login: 3500

Adgangskode til login: 3500

(DE)

Login-Benutzername: 3500

Login-Password: 3500

(IT)

Nome utente login: 3500

Password login: 3500

(NL)

Login gebruikersnaam: 3500

Aanmeldingswachtwoord: 3500

(NO)

Brukernavn: 3500

Passord: 3500

(PL)

Nazwa logowania: 3500

Hasło logowania: 3500

(PT-BR)

Nome usuário de login: 3500

Senha de login: 3500

(PT-PT)

Nome Utilizador Início de Sessão: 3500

Palavra passe Início Ses.: 3500

(EL)

Όνομα χρήστη σύνδεσης: 3500

Κωδικός πρόσβ. Σύνδεσης: 3500

(ES)

Nombre de usuario de inicio de sesión: 3500

Contraseña inicio sesión: 3500

(FI)

Sis.kirj. käyttäjänimi: 3500

Sis.kirj. salasana: 3500

(FR)

Nom de connexion de l'ut.: 3500

Mot de passe connexion: 3500

(HU)

Bejelentkezési felhasználónév: 3500

Bejelentkezési jelszó: 3500

(RO)

Nume Utilizator Conectare: 3500

Parolă Conectare: 3500

(RU)

Имя пользователя при входе: 3500

Пароль при входе: 3500

(SV)

Inloggningsanvändarnamn: 3500

Inlogg.användarlösenord: 3500

(TR)

Oturum Açma Kullanıcı Adı: 3500

Oturum Açma Parolası: 3500

(AR)

3500 اسم الدخول:

3500 كلمة مرور الدخول:

1

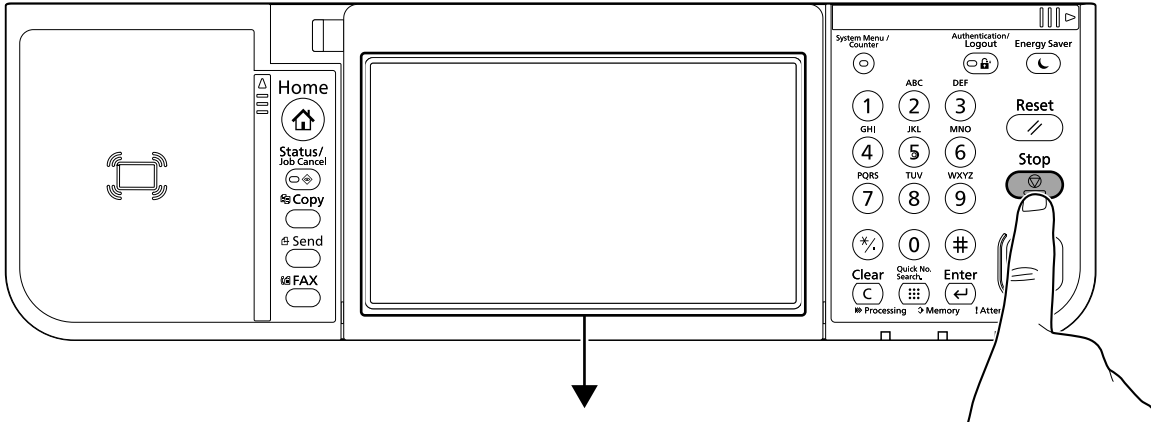

2

EN

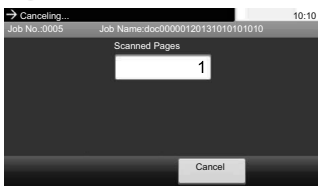

CA

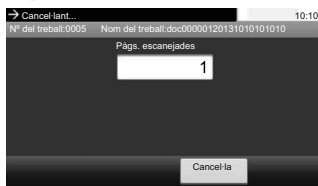

CS

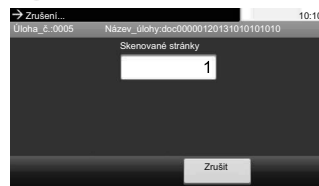

DA



DE



EL

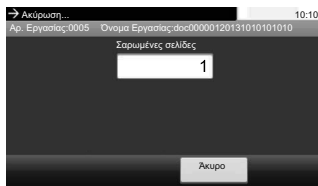

ES

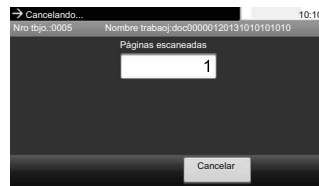

FI

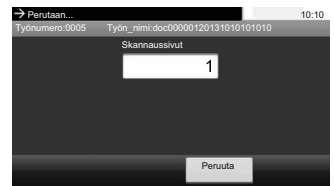

FR



HU

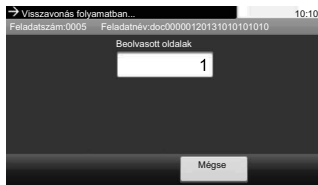

IT

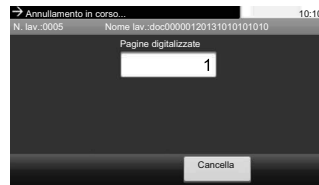

NL

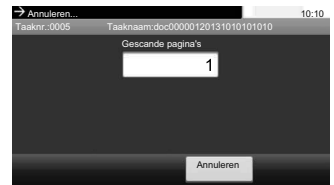

NO



PL

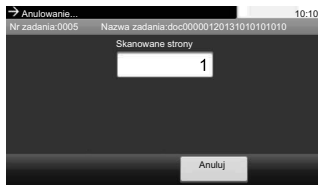

PT-BR

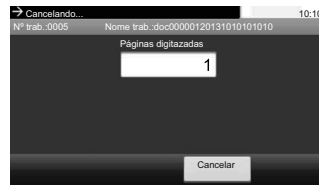

PT-PT

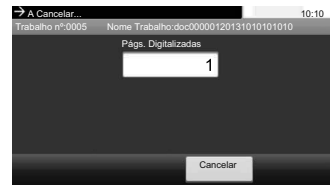

RO



RU

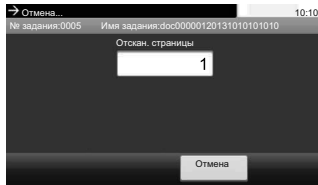

SV



TR



AR



EN

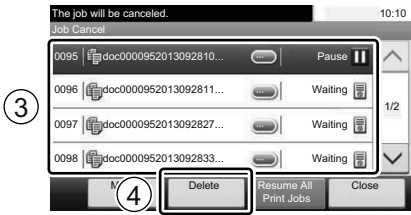

CA



CS



DA

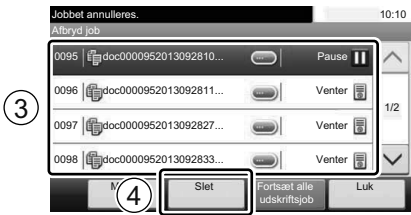

DE

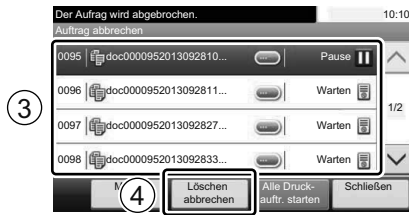

EL



ES

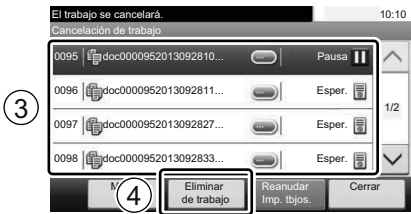

FI

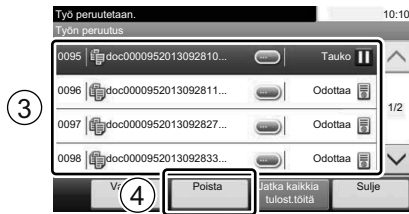

FR

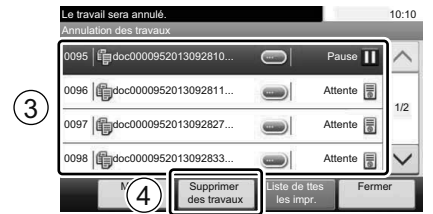

HU

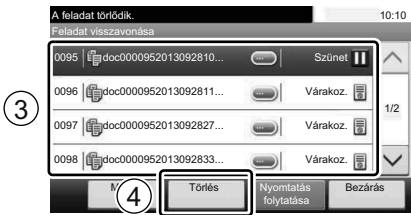

IT

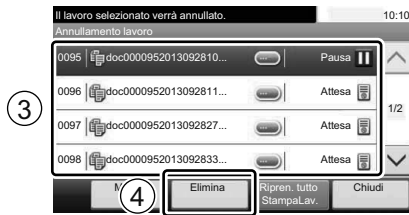

NL



NO



PL

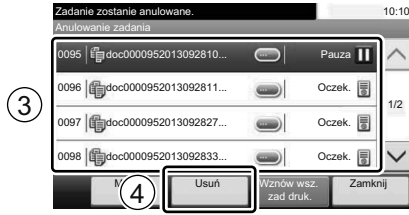

PT-BR

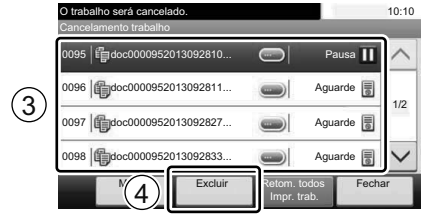

PT-PT

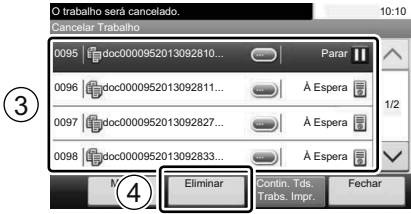

RO



RU



SV

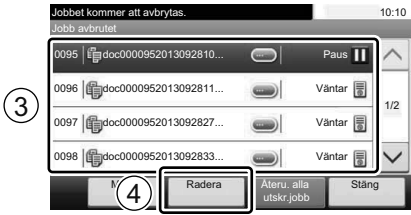

TR

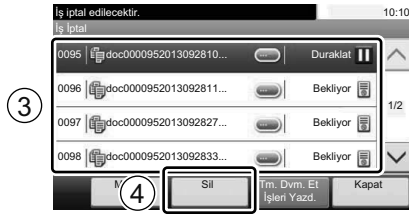

AR

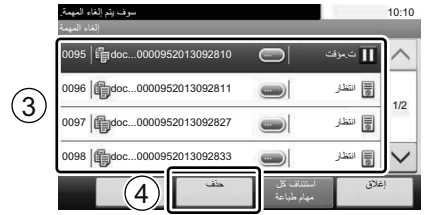

1

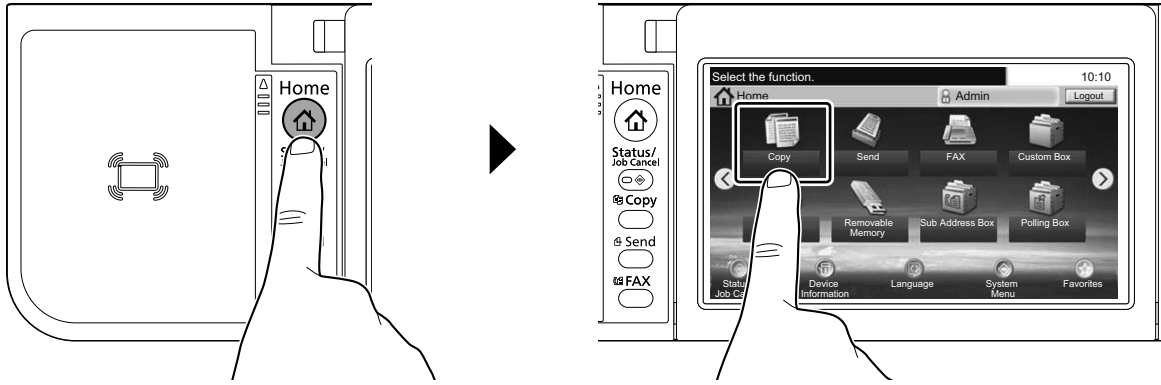

2

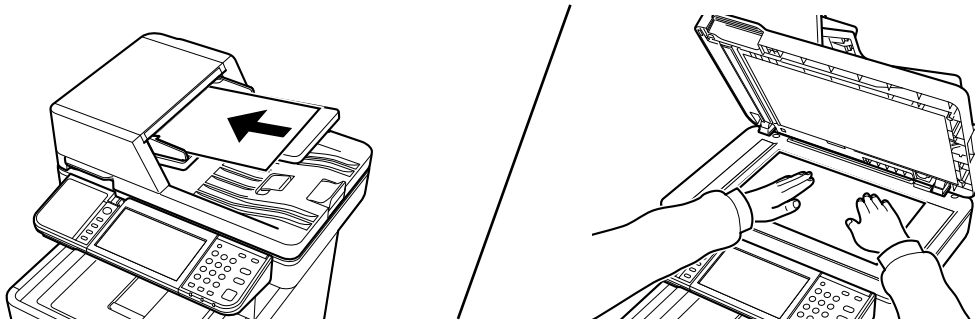

3

EN

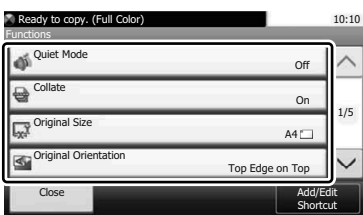
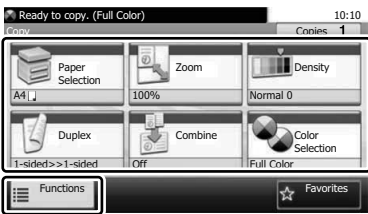

CA

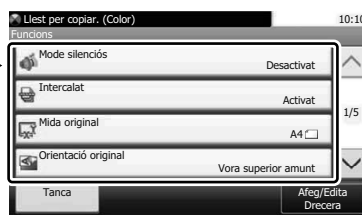
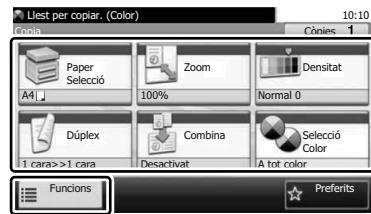

CS

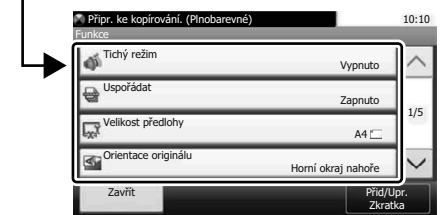

DA

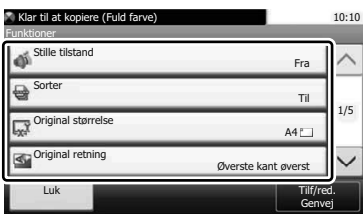
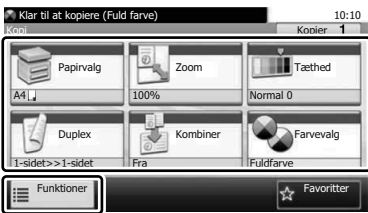

DE

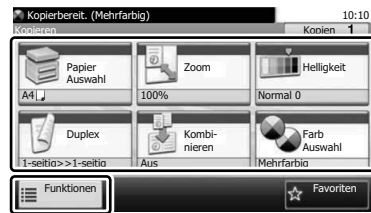

EL

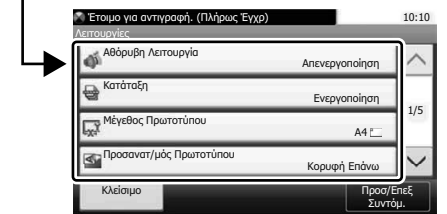

ES

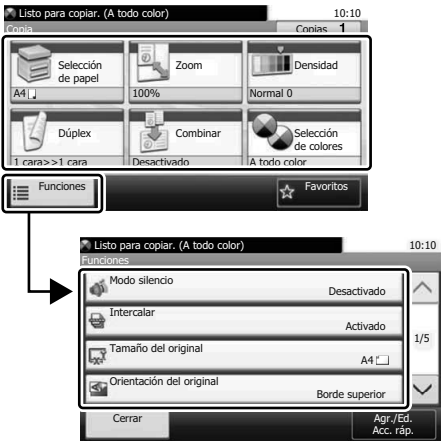

FI

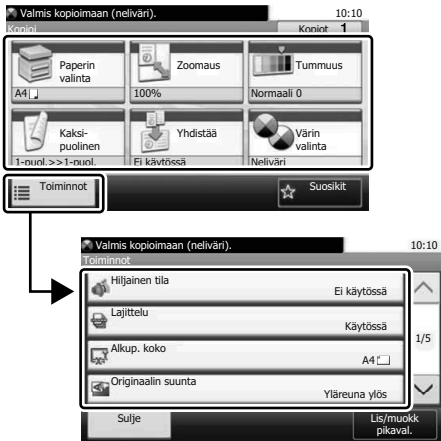

FR

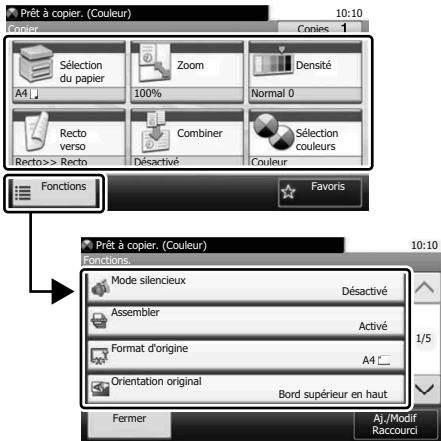

HU

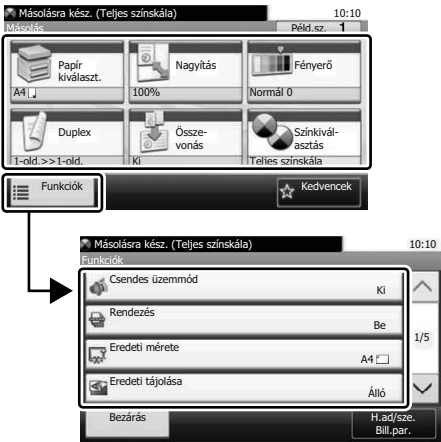

IT

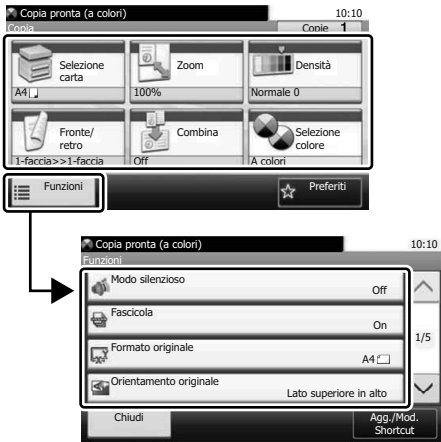

NL

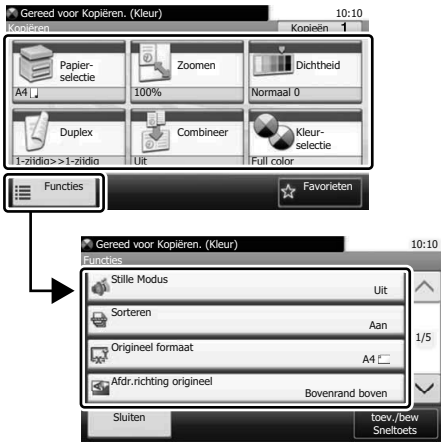

NO

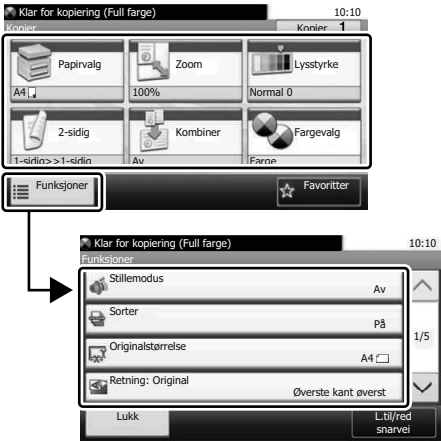

PL

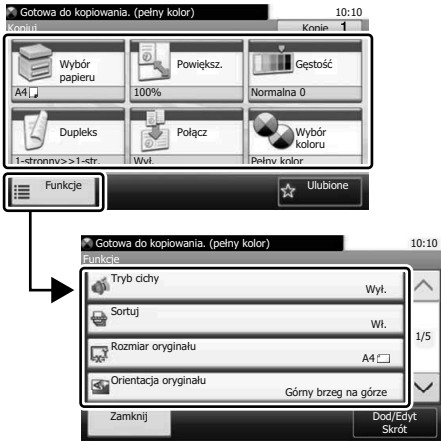

PT-BR

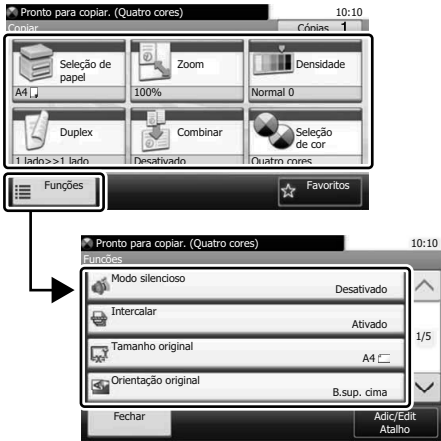

PT-PT

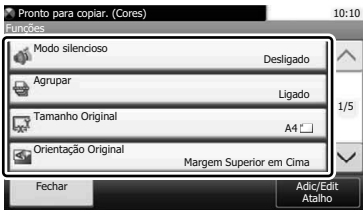
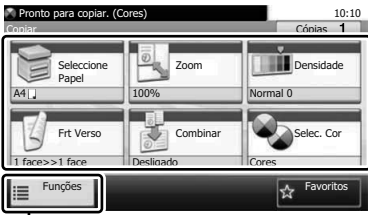

RO

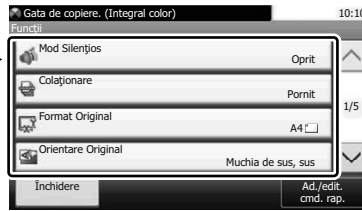
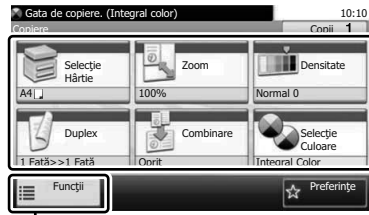

RU

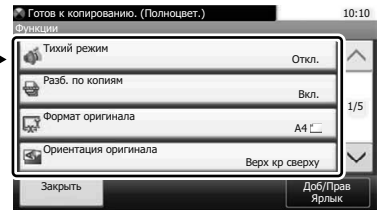

SV

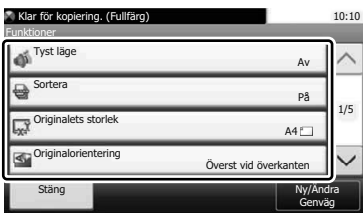
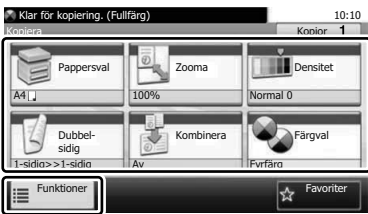

TR



AR

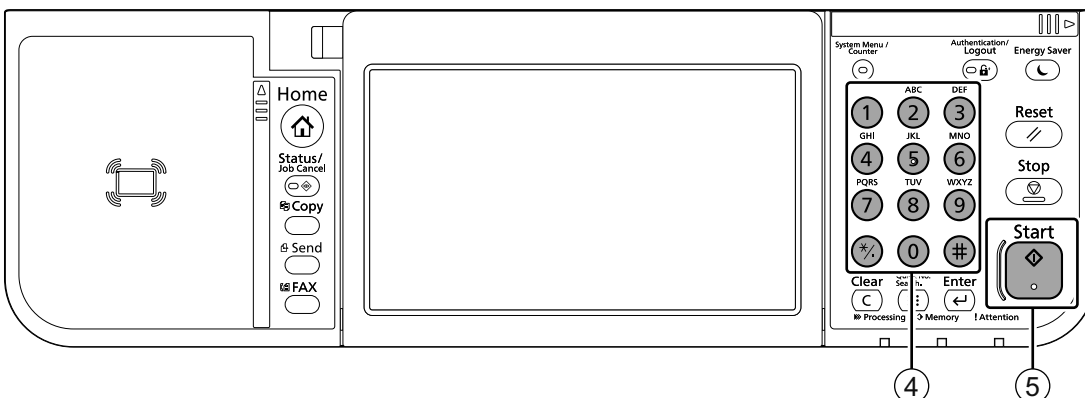

Setup

EN

- 1 Launch your Web browser.
- 2 In the Address or Location bar, enter the machine's IP address or Printer Host Name.

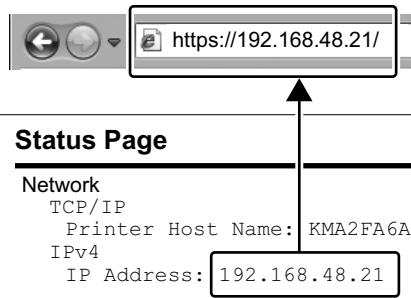

- 3 Enter the following and log in to Command Center RX with administrator authority.

Admin Login	User Name	Admin
	Password	Admin
	Login	

- 4 From the [Function Settings] menu, click [E-mail].

- 5 Set SMTP Protocol [On], and then enter the following items.
 - SMTP Server Name
 - E-mail Size Limit
 - Sender Address

CA

- 1 Inicieu el navegador web.
- 2 A la barra d'adreeses o d'ubicació, introduïu l'adreça IP del dispositiu o el nom de l'amfitrió de la impressora.

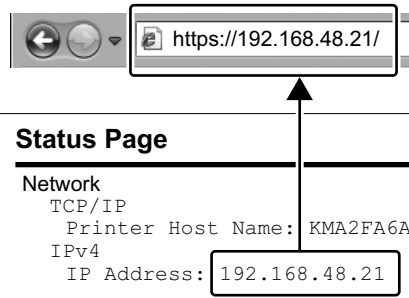

- 3 Introduïu les dades següents i inicieu la sessió a Command Center RX amb privilegis d'administrador.

Inicia sessió com a administrador	Nom d'usuari	Admin
	Contrasenya	Admin
	Inicia sessió	

- 4 Al menú [Configuració de funcions], feu clic a [E-mail].

- 5 Establiu el Protocol SMTP en [Activat] i introduïu les dades següents.
 - Nom del servidor SMTP
 - Limit de mida de l'E-mail
 - Adreça del remitent

CS

- 1 Spust'te váš webový prohlížeč.
- 2 V záložce Adresa nebo Umístění zadejte IP adresu zařízení nebo jméno hostitelské tiskárny.

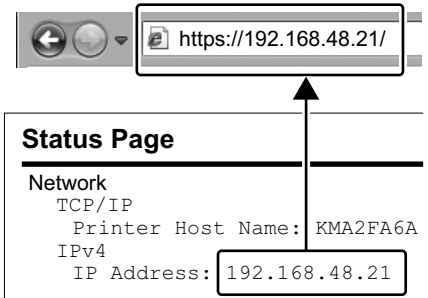

- 3 Zadejte níže uvedené informace a přihlaste se do Command Center RX s administrátorským oprávněním.

Přihlášení správce	Uživatelské jméno	Admin
	Heslo	Admin
	Přihlášení	

- 4 V nabídce [Nastavení funkcí] klikněte na [E-mail].

- 5 Nastavte protokol SMTP na [Zapnuto], a poté zadejte následující položky.
 - Název serveru SMTP
 - Limit velikosti e-mailu
 - Adresa odesílatele

DA

- 1 Start din webbrower.
- 2 Indtast maskinens IP-adresse eller printerens værtnavn i adresse- eller placeringslinjen.

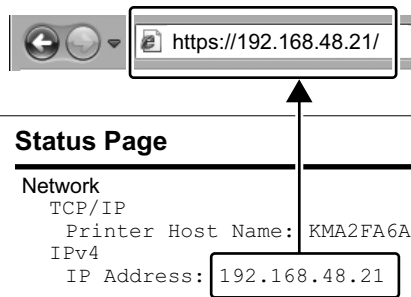

- 3 Indtast følgende og log ind i Command Center RX med administratorrettigheder.

Administratorlogon	Brugernavn	Admin
	Adgangskode	Admin
	Log på	

- 4 I menuen [Funktionsindstillinger], klik på [E-mail].

- 5 Indstil SMTP-protokol til [Til], og indtast derpå følgende enheder.
 - SMTP-servernavn
 - Størrelsesbegrænsning på e-mails
 - Afsenderadresse

DE

- 1 Starten Sie Ihren Webbrowser.
- 2 In der Adresszeile geben Sie die IP-Adresse des Geräts oder den Hostnamen wie eine Internetadresse (URL) ein.

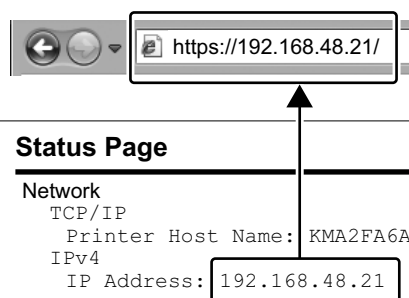

- 3 Geben Sie Folgendes ein und melden sich am Command Center RX mit Administrator-Rechten an.

Admin Anmeldung	Anwendername	Admin
	Passwort	Admin
	Anmelden	

- 4 Im Menü [Funktions-Einstellungen] klicken Sie auf [E-Mail].

- 5 Stellen Sie das SMTP-Protokoll auf [Ein] und geben Sie die folgenden Punkte ein.
 - SMTP-Servername
 - E-Mail-Größenlimit
 - Absenderadresse

EL

- 1 Εκκινήστε το πρόγραμμα περιήγησής σας στο Internet.
- 2 Στο πλαίσιο Διεύθυνση ή Τοποθεσία, εισάγετε τη διεύθυνση IP του μηχανήματος ή το όνομα του κεντρικού εκτυπωτή.

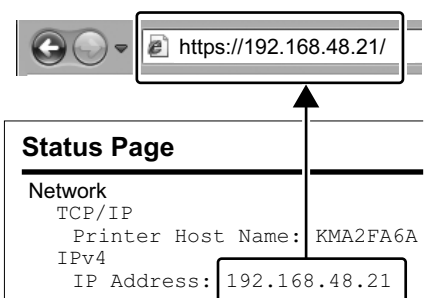

- 3 Εισάγετε τα ακόλουθα και συνδεθείτε στο Command Center RX με δικαιώματα διαχειριστή.

Σύνδεση Διαχειριστή	Όνομα χρήστη	Admin
	Κωδικός πρόσβασης	Admin
	Σύνδεση	

- 4 Από το μενού [Ρυθμίσεις Λειτουργιών], κάντε κλικ στο [E-mail].

- 5 Ρυθμίστε το Πρωτόκολλο SMTP σε [Ενεργοποίηση], και έπειτα εισάγετε τα ακόλουθα στοιχεία.
 - Όνομα διακομιστή SMTP
 - Όριο μεγέθους e-mail
 - Διεύθυνση αποστολέα

ES

- 1 Inicie el explorador de Internet.
- 2 En la barra de direcciones o de ubicación, introduzca la dirección IP de la máquina o el nombre de host de la impresora.

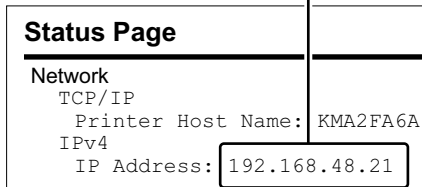

- 3 Introduzca lo siguiente e inicie sesión en Command Center RX con autoridad de administrador.

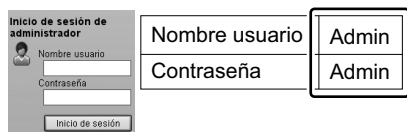

- 4 En el menú [Configuración de función], haga clic en [E-mail].

- 5 Configure Protocolo SMTP como [Activado] y después introduzca los valores de los siguientes elementos.

- Nombre de servidor SMTP
- Tam. lím. e-m.
- Dirección del remitente

FI

- 1 Käynnistä verkkoselaimesi.
- 2 Kirjoita IP-osoite osoiteriville tai sijaintipalkkiin tietokoneen tai tulostinpalvelimen isäntänimi.

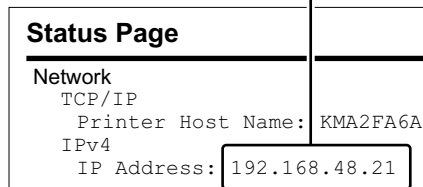

- 3 Syötä seuraava, ja kirjaudu Command Center RX:ään ylläpitäjän tunnuksilla.

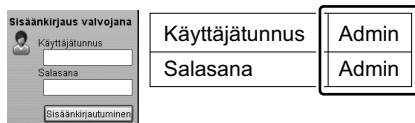

- 4 Klikkaa [Sähköposti] [Toimintoasetus] -valikosta.

- 5 Aseta SMTP-protokolla [Käytössä] -asentoon ja syötä seuraavat tiedot.

- SMTP-palvelimen nimi
- Sähköpostin kokorajoitus
- Lähettäjän osoite

FR

- 1 Lancer le navigateur Internet.
- 2 Dans la barre d'adresses ou d'emplacement, saisir l'adresse IP de la machine ou le nom d'hôte de l'imprimante.

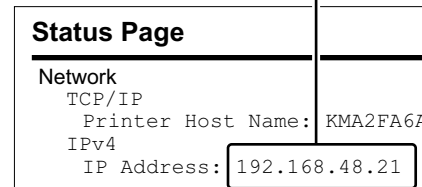

- 3 Saisir les informations suivantes et se connecter à Command Center RX avec des droits d'administrateur.

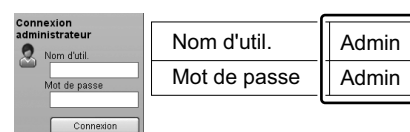

- 4 Dans le menu [Paramètres de fonction], cliquer sur [E-mail].

- 5 Régler le protocole SMTP sur [Activé], puis saisir les informations suivantes.

- Nom de serveur SMTP
- Lim. taille e-mail
- Adresse de l'expéditeur

HU

- 1 Indítsa el a webböngészőjét.
- 2 A címsorba vagy a hely sávjába írja be a készülék IP címét vagy a nyomtató állomásnevét.

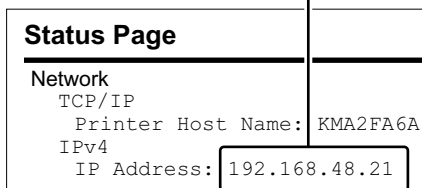

- 3 Írja be az alábbiakat, és rendszergazdai jogosultságokkal jelentkezzen be a Command Center RX alkalmazásba.

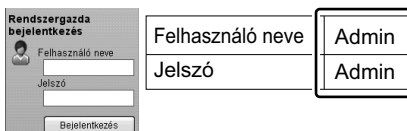

- 4 A [Funkcióbeállítások] menüben kattintson az [E-mail] lehetőségre.

- 5 Az SMTP protokoll opciót kapcsolja [Be], és adja meg az alábbi tételeket.

- SMTP-szerver neve
- E-mail méretkorlátozása
- Feladó címe

IT

- 1 Avviare il browser web.
- 2 Nella barra degli indirizzi, immettere l'indirizzo IP della macchina oppure il Nome host della stampante.

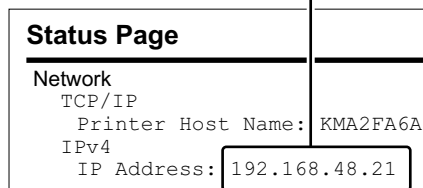

- 3 Immettere le seguenti voci e accedere a Command Center RX con privilegi di amministratore.

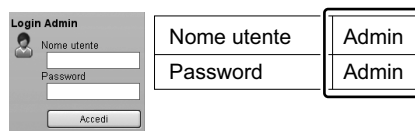

- 4 Nel menu [Impostazioni di funzione], fare clic su [Posta elettronica].

- 5 Impostare Protocollo SMTP su [On], quindi immettere le seguenti voci.

- Nome server SMTP
- Limite dim. email
- Indirizzo mittente

NL

- 1 Start uw webbrowser.
- 2 In de adres-of locatiebalk, voer het IP-adres van het apparaat of printer hostnaam in.

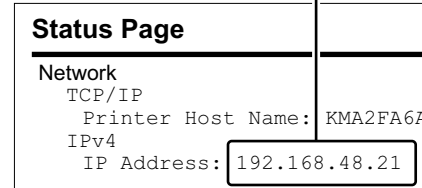

- 3 Voer het volgende in en meld u aan bij Command Center RX met beheerdersrechten.



- 4 In het menu [Functie-instellingen], klik op [E-mail].

- 5 Stel SMTP-protocol in op [Aan] en voer vervolgens de volgende items in.

- SMTP-servernaam
- Groottebeperking e-mail
- Adres afzender

NO

- 1 Åpne webleseren din.
- 2 Legg inn maksinens IP-adresse eller skriverens vertsnavn i adresselinjen.

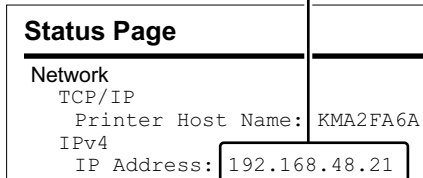

- 3 Tast inn følgende og logg deg på Command Center RX med administratorrettigheter.

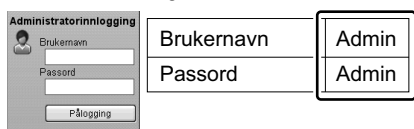

- 4 Fra menyen [Funksjoninnstillinger], klikk på [E-post].
- 5 Sett SMTP-protokoll [På], og tast deretter inn følgende elementer.
 - SMTP-servernavn
 - Størrelsesgrense for e-post
 - Avsenderadresse

PL

- 1 Uručom przeglądarkę internetową.
- 2 W polu na pasku adresu lub lokalizacji wprowadź adres IP urządzenia lub nazwę hosta drukarki.



- 3 Wprowadź następujące poświadczenia, aby zalogować się do narzędzia Command Center RX na konto z uprawnieniami administratora.

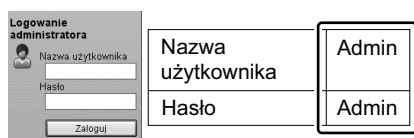

- 4 Z menu [Ustawienia funkcji] wybierz polecenie [E-mail].
- 5 Dla ustawienia Protokół SMTP wybierz wartość [Wi.], a następnie wprowadź wartości następujących ustawień.
 - Nazwa serwera SMTP
 - Limit rozmiaru e-mail
 - Adres nadawcy

PT-BR

- 1 Inicie o seu navegador web.
- 2 Na barra Endereço ou Local, insira o endereço de IP da máquina ou o nome do host da impressora.

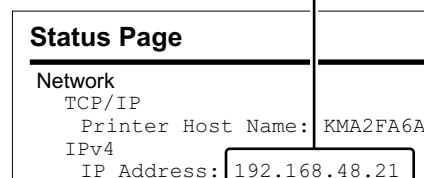

- 3 Insira o seguinte e faça o login no Command Center RX com autoridade de administrador.

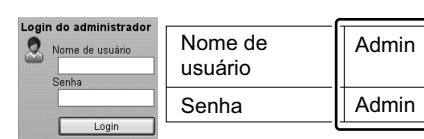

- 4 No menu [Configurações da função], clique em [E-mail].
- 5 Defina o Protocolo SMTP como [Ativado] e depois insira os seguintes itens.
 - Nome do servidor de SMTP
 - Lim.tam. p/e-mail
 - Endereço do remetente

PT-PT

- 1 Abra o seu browser.
- 2 Na barra de endereço ou localização insira o endereço IP da máquina ou Nome de Anfitrião da Impressora.

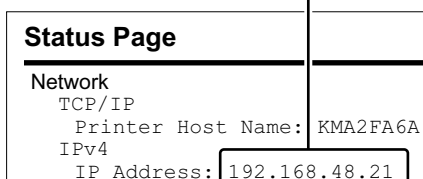

- 3 Insira o seguinte e inicie sessão no Command Center RX com permissão de administrador.

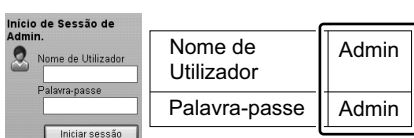

- 4 A partir do menu [Definições da função], clique em [E-mail].
- 5 Defina o Protocolo SMTP para [Ligado] e insira os seguintes itens.
 - Nome do Servidor SMTP
 - Limite de Tamanho de E-mail
 - Endereço do Destinatário

RO

- 1 Lansati browserul dvs. de internet.
- 2 În bara de adrese sau poziție, introduceți adresa IP a aparatului sau numele de gazdă al imprimantei.

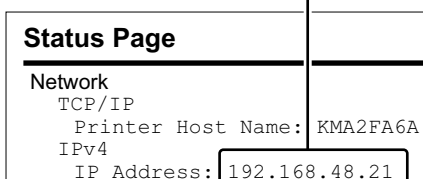

- 3 Introduceți următoarele și conectați-vă la Command Center RX cu autoritate de administrator.

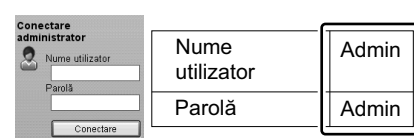

- 4 Din meniul [Setări funcționale], faceți clic pe [E-mail].
- 5 Setări Setări Protocol SMTP pe [Pornit], și apoi introduceți următoarele elemente.
 - Nume server SMTP
 - Limită dimensiune e-mail
 - Adresă expeditor

RU

- 1 Запустите веб-обозреватель.
- 2 В строке «Адрес» или «Местоположение» введите IP-адрес аппарата или имя хоста принтера.

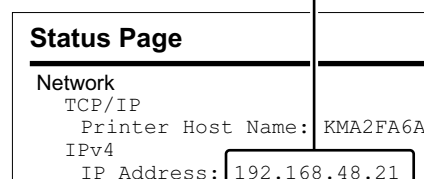

- 3 Введите следующие данные и выполните вход в систему Command Center RX с правами администратора.

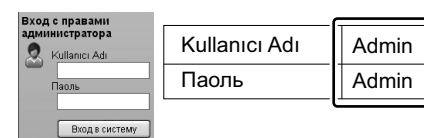

- 4 В меню [Настройки функций] выберите [Электронная почта].
- 5 Для протокола SMTP Установите [Вкл.], а затем введите следующие данные.
 - Имя сервера SMTP
 - Предел размера сообщения эл. почты
 - Адрес отправителя

SV

- 1 Starta din webbläsare.
- 2 Skriv in maskinens IP-adress eller skrivarens värddamn i adressfältet.

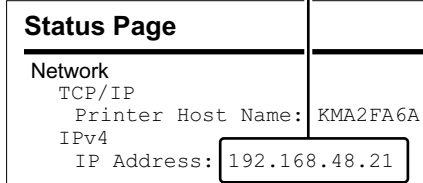

- 3 Skriv in följande och logga in i Command Center RX som administratör.

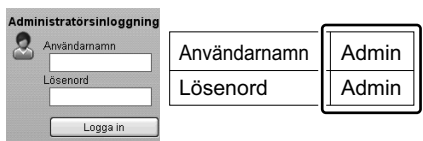

- 4 Från menyn [Funktionsinställningar], klicka på [E-post].
- 5 Aktivera SMTP-protokoll [På], och skriv sedan in följande uppgifter.
 - SMTP-servernamn
 - Storleksbegränsning för e-postmeddelanden
 - Avsändaradress

TR

- 1 Web tarayıcınızı açın.
- 2 Adres veya Yer çubuğuna, makinenin IP adresini yazın.

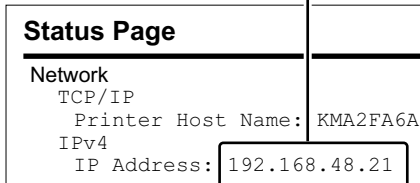

- 3 Aşağıdakileri girin veya yönetici yetkisiyle Command Center RX'de oturum açın.

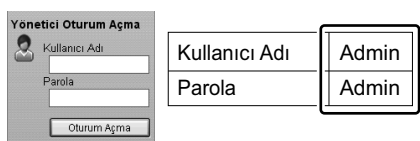

- 4 [Fonksiyon Ayarları] menüsünden, [E-posta] üzerine tıklayın.
- 5 SMTB protokolü ayarını [Açık] konumuna getirin ve sonra aşağıdaki öğeleri yazın.
 - SMTP Sunucu Adı
 - E-posta Boyutu Sınırı
 - Gönderen Adresi

AR

- 1 افتح مستعرض الإنترنت الخاص بك.
- 2 في شريط الموقع أو العنوان، أدخل عنوان IP الخاص بالجهاز أو اسم مضيف الطباعة.

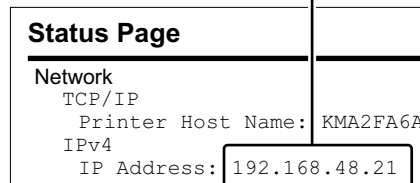

- 3 أدخل ما يلي وسجل للدخول في Command Center RX بامتيازات المدير المسؤول.

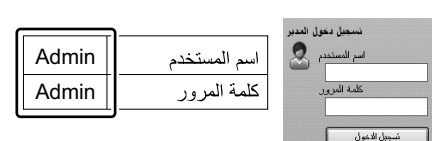

- 4 من القائمة [إعدادات الوظائف]، انقر فوق [البريد الإلكتروني].
- 5 اضبط بروتوكول SMTP على وضع [تشغيل]، ثم أدخل العناصر التالية.
 - اسم ملقم SMTP
 - حدود حجم البريد الإلكتروني
 - عنوان المرسل

Send

1

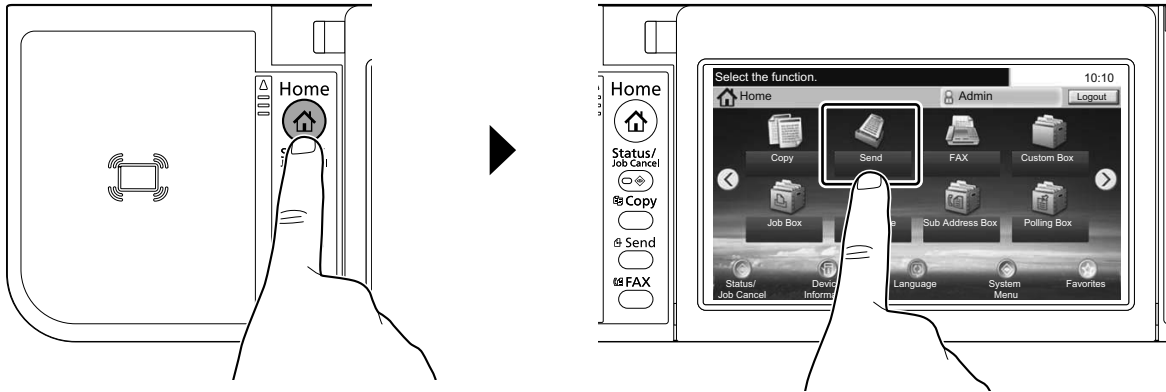

2

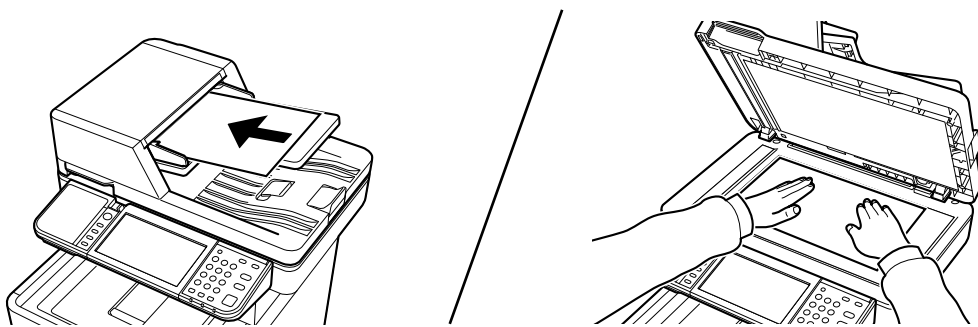

3

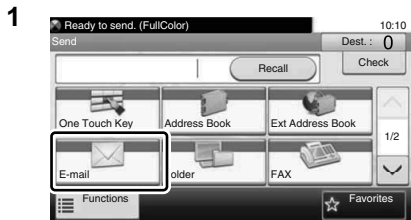

4

1

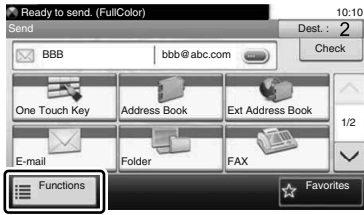

2

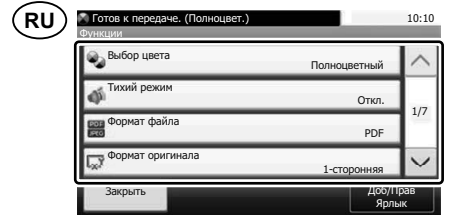
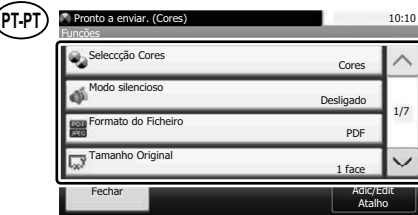
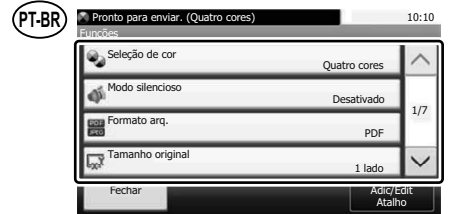
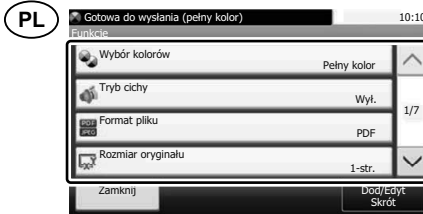
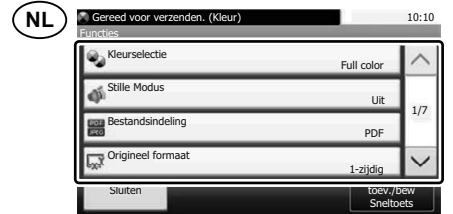
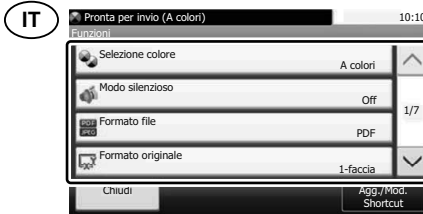
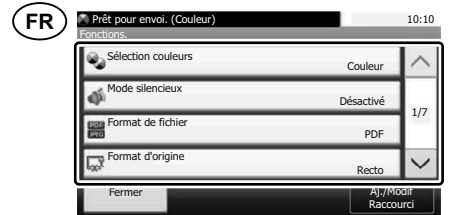
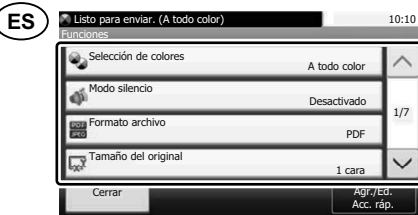
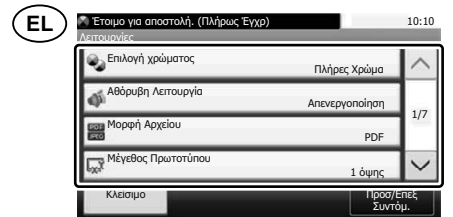
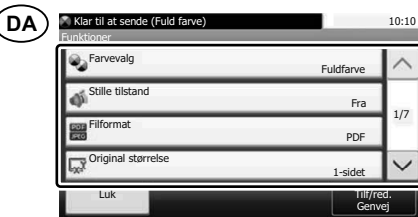
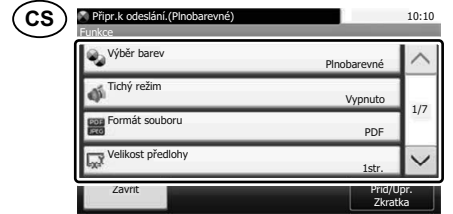
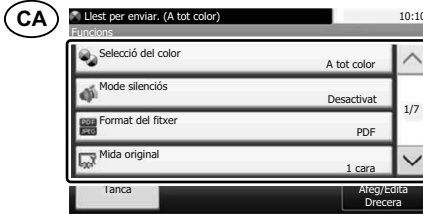
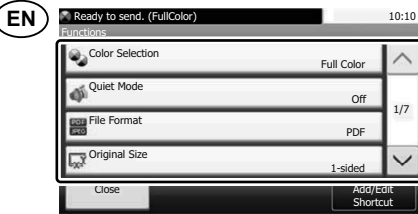



5

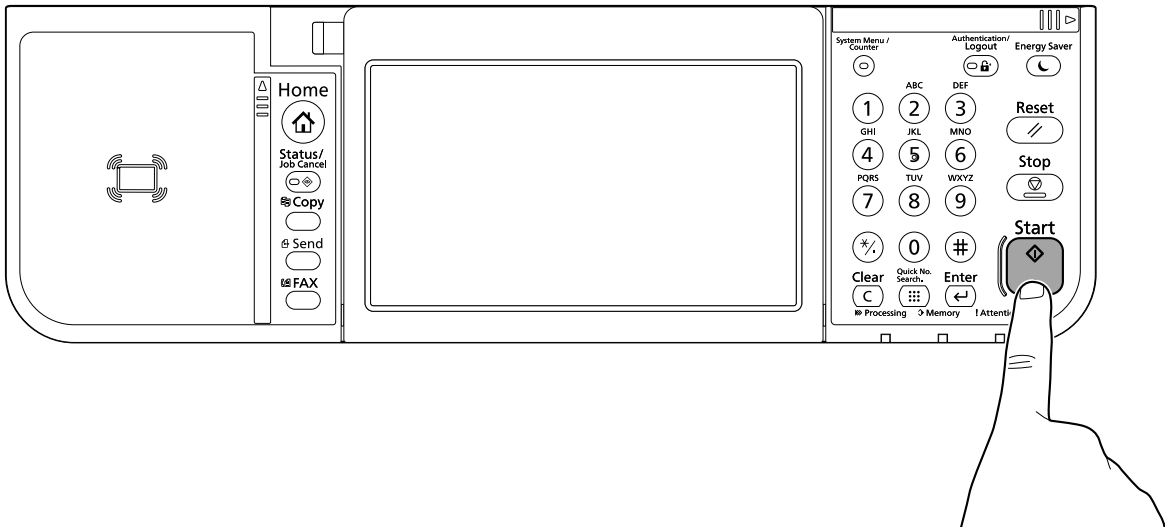

1

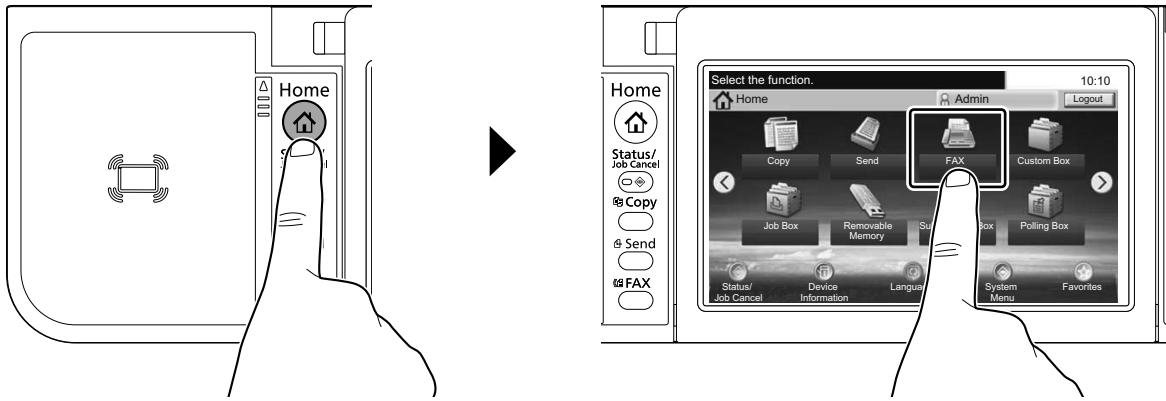

2

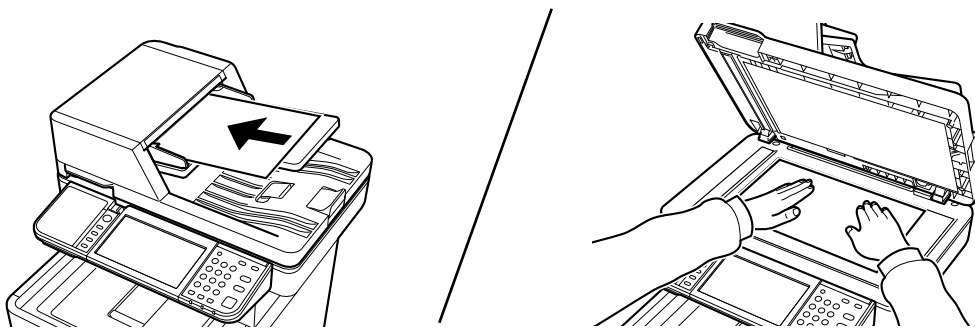

3

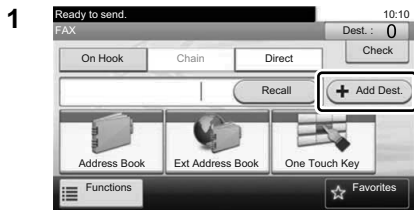

2 EN

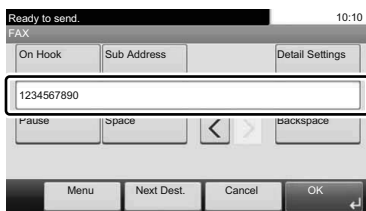

CA

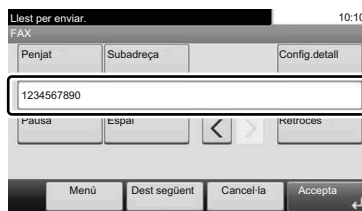

CS

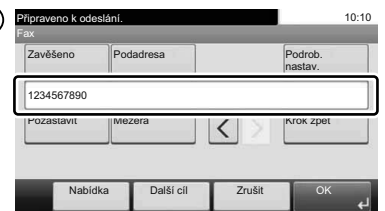

DA

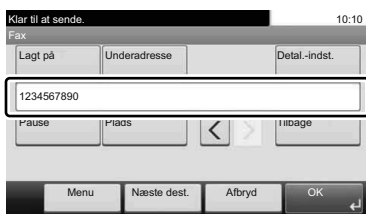

DE

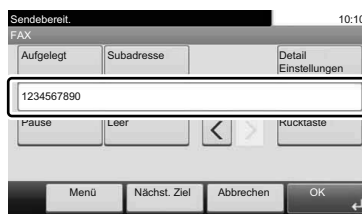

EL

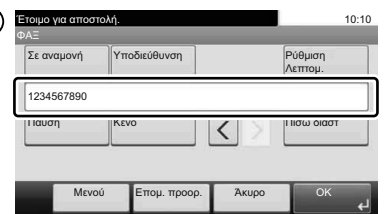

ES

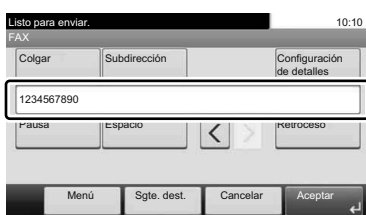

FI

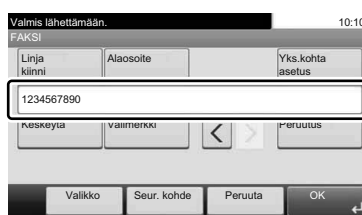

FR

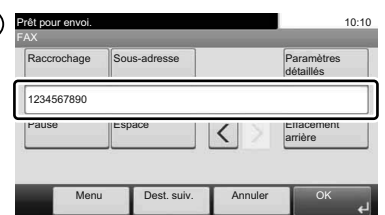

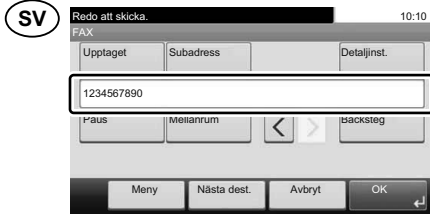
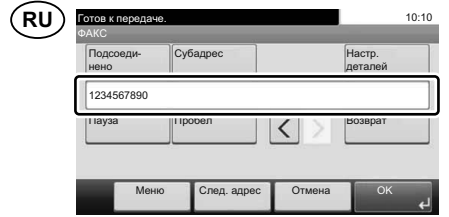
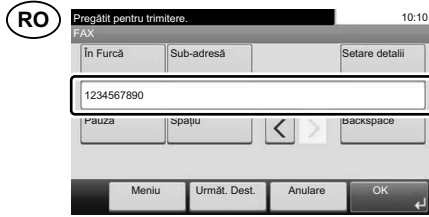
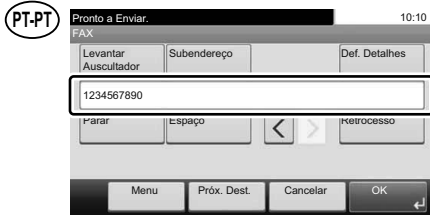
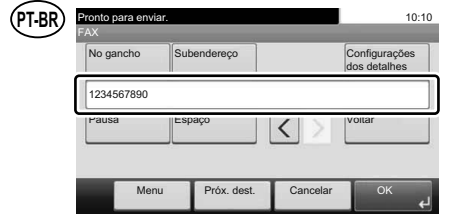
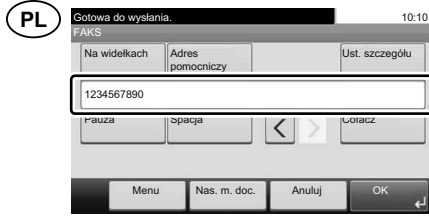
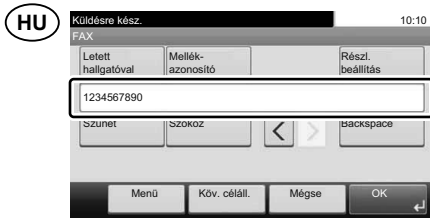

4

1

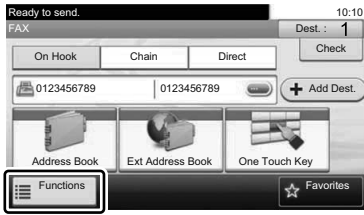

2

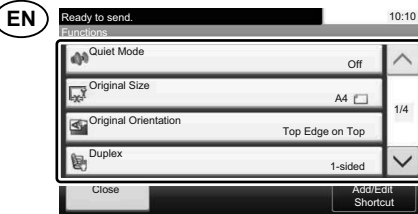

CA

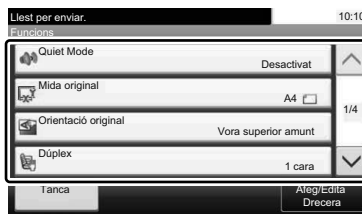

CS

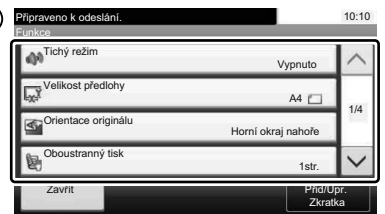

DA

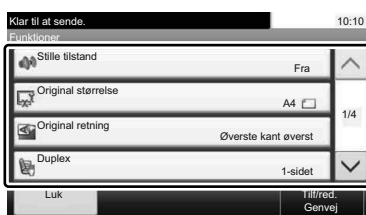

DE



EL



ES

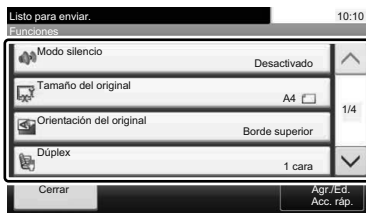

FI

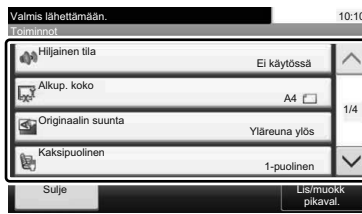

FR



HU

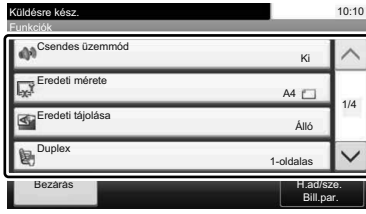

IT

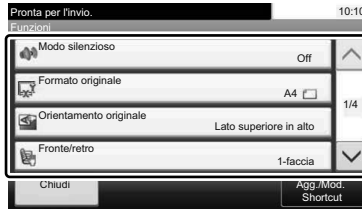

NL

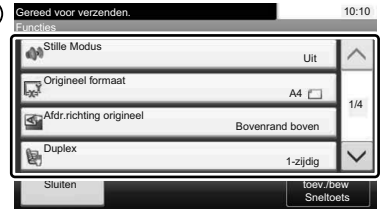

NO

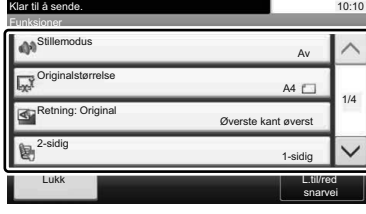

PL

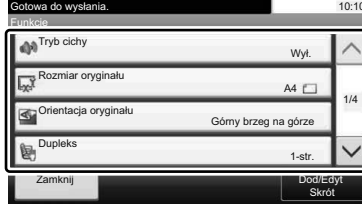

PT-BR

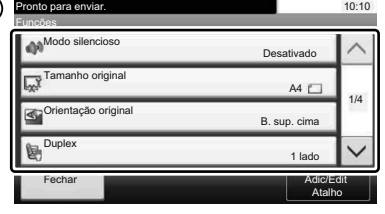

PT-PT

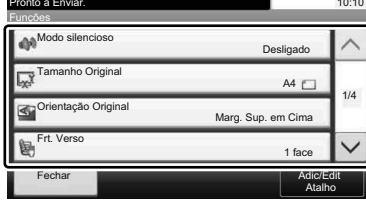

RO

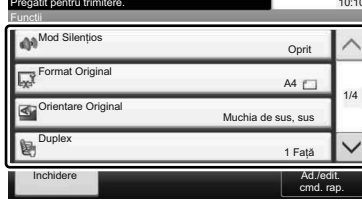

RU

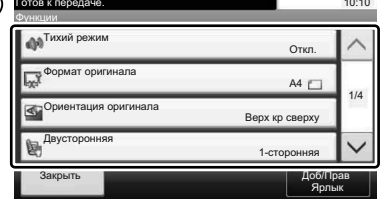



5

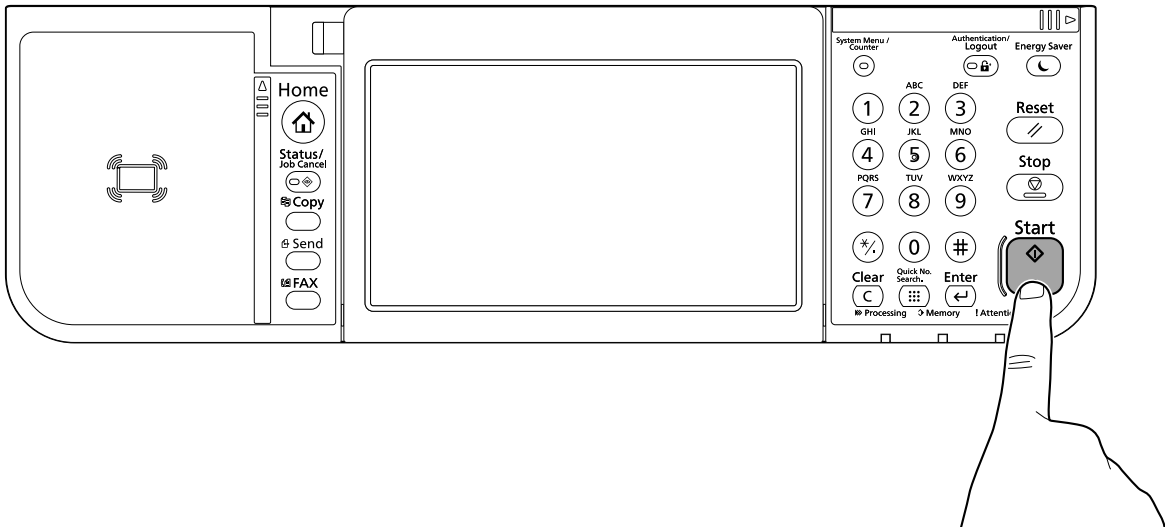

From a PC

①

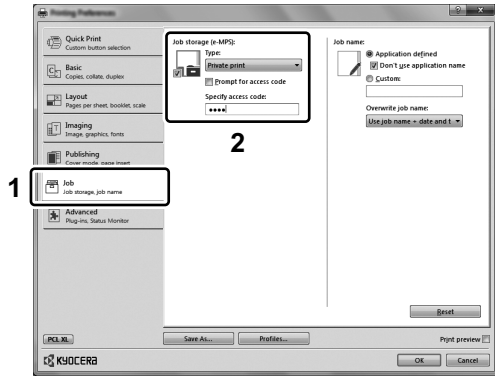

- ① EN To activate the private printing from the PC, set the items No. 1 and 2 in the screen.
- ① CA Per activar la impressió privada des d'un PC, configureu els elements núm. 1 i núm. 2 de la pantalla.
- ① CS Pro aktivaci soukromého tisku z počítače vyberte položku č.1 a 2 na obrazovce.
- ① DA For at aktivere privat udskrivning fra pc'en, indstilles enheder nr. 1 og 2 på skærmen.
- ① DE Um den privaten Druck vom PC aus zu aktivieren, stellen Sie die Punkte 1 und 2 am Bildschirm ein.
- ① EL Για να ενεργοποιήσετε την ιδιωτική εκτύπωση από τον υπολογιστή, ορίστε τα στοιχεία Αρ. 1 και 2 στην οθόνη.
- ① ES Para activar la impresión privada desde el PC, configure los elementos número 1 y 2 en la pantalla.
- ① FI Aktivoidaksesi yksityisen tulostuksen PC:ltä, aseta tiedot nro 1 ja 2 ruudulla.
- ① FR Pour activer l'impression privée à partir de l'ordinateur, définir les éléments 1 et 2 sur l'écran.
- ① HU A magán nyomtatás számítógépről történő aktiváláshoz a képernyőn állítsa be az 1. és a 2. tételt.
- ① IT Per attivare la stampa privata da PC, configurare le voci N. 1 e N. 2 sulla schermata.
- ① NL Om privé afdrucken vanaf de pc te activeren, stel de items nummer 1 en 2 op het scherm in.
- ① NO For å aktivere privat utskrift fra PC, sett element nr. 1 og 2 på skjermen.
- ① PL Aby aktywować drukowanie prywatne z poziomu komputera, skonfiguruj ustawienia oznaczone cyframi 1 i 2 na tym ekranie.
- ① PT-BR Para ativar a impressão privada no PC, defina os itens N. 1 e 2 na tela.
- ① PT-PT Para activar a impressão privada no PC, configure os itens n.º 1 e 2 no ecrã.
- ① RO Pentru a activa imprimarea privată de la PC, setați elementele 1 și 2 de pe ecran.
- ① RU Для активации конфиденциальной печати с ПК выполните настройку пунктов 1 и 2 на экране.
- ① SV För att aktivera funktionen privat utskrift från PC:n, ställ in uppgifterna nr 1 och 2 på skärmen.
- ① TR PC'den özel yazdırma işlemini aktive etmek için, ekranda madde No.1 ve 2'yi ayarlayın.
- ① AR لتشغيل الطباعة الشخصية من جهاز الكمبيوتر، عين العنصرين رقم 1 و2 في الشاشة.

From the Operation Panel

1

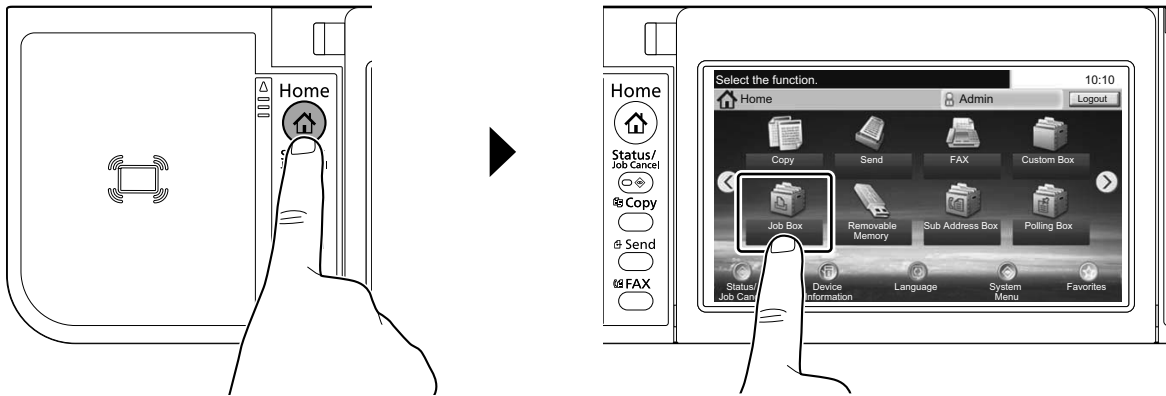

2

EN

CA

CS

DA

<p>1</p>	<p>1</p>	<p>1</p>	<p>1</p>
<p>2</p>	<p>2</p>	<p>2</p>	<p>2</p>
<p>3</p>	<p>3</p>	<p>3</p>	<p>3</p>
<p>4</p>	<p>4</p>	<p>4</p>	<p>4</p>
<p>5</p>	<p>5</p>	<p>5</p>	<p>5</p>
<p>6</p>	<p>6</p>	<p>6</p>	<p>6</p>
<p>7</p>	<p>7</p>	<p>7</p>	<p>7</p>
<p>8</p>	<p>8</p>	<p>8</p>	<p>8</p>

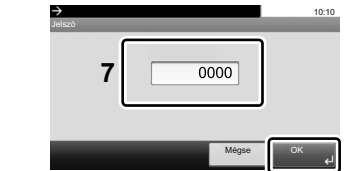
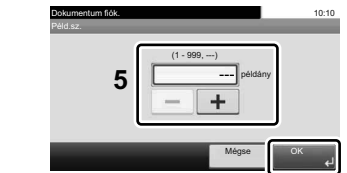
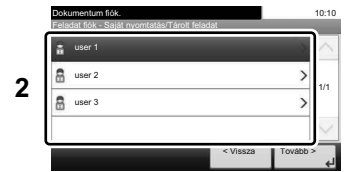
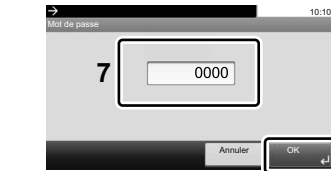
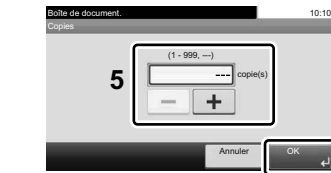
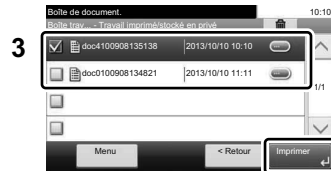
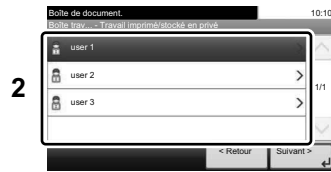
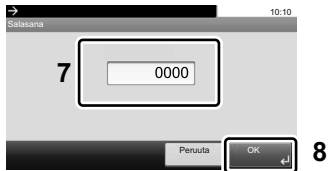
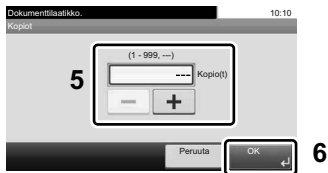
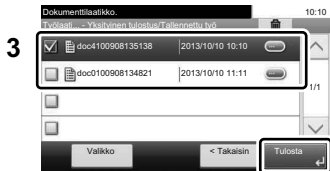
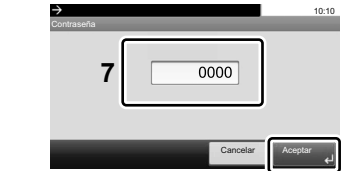
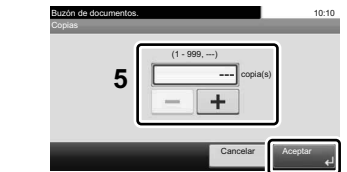
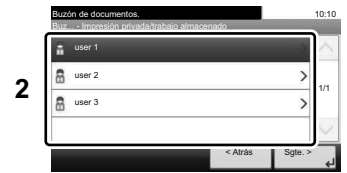
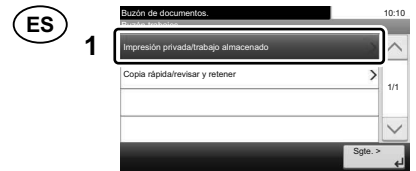
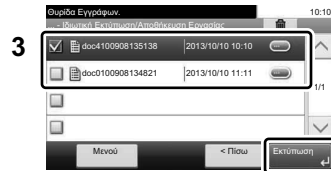
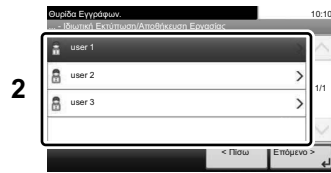
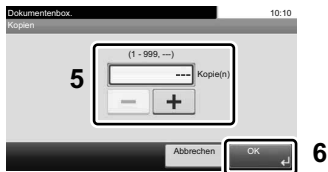

IT

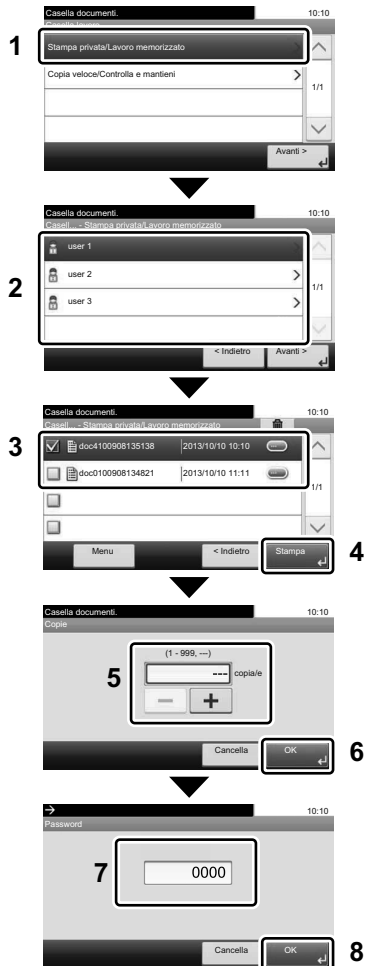

NL

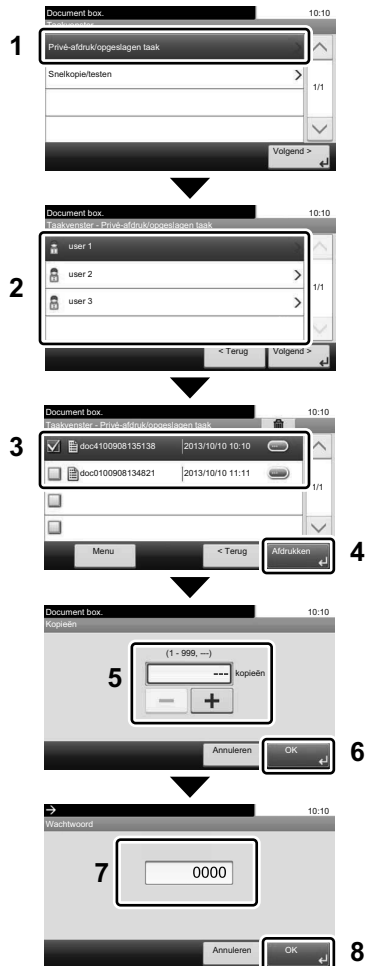

NO

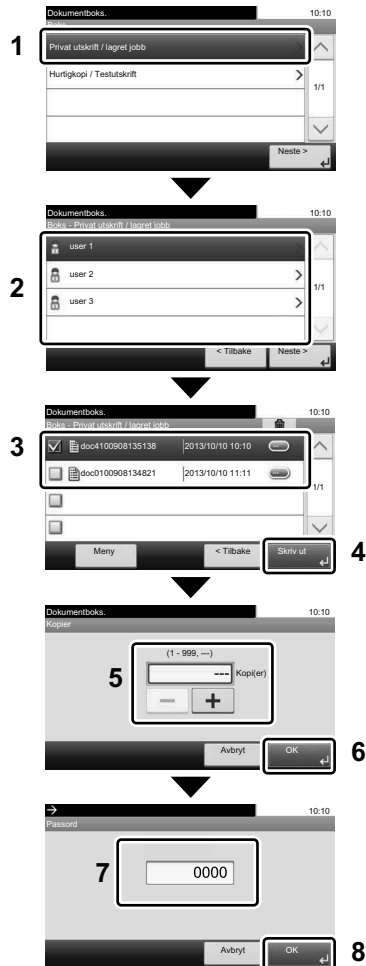

PL

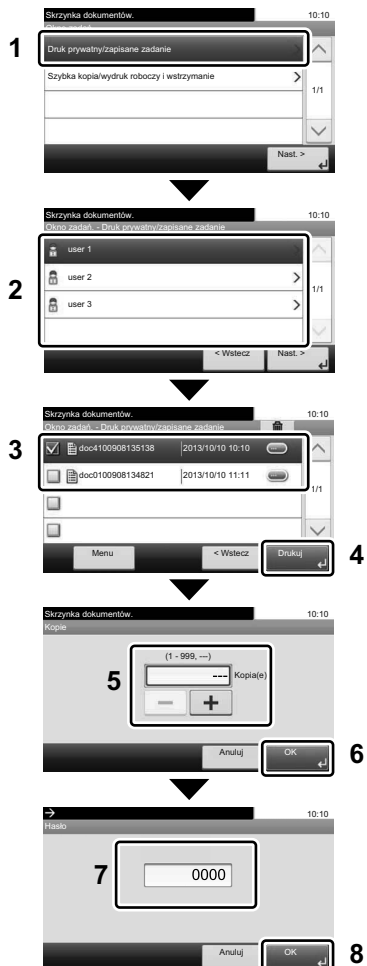

PT-BR

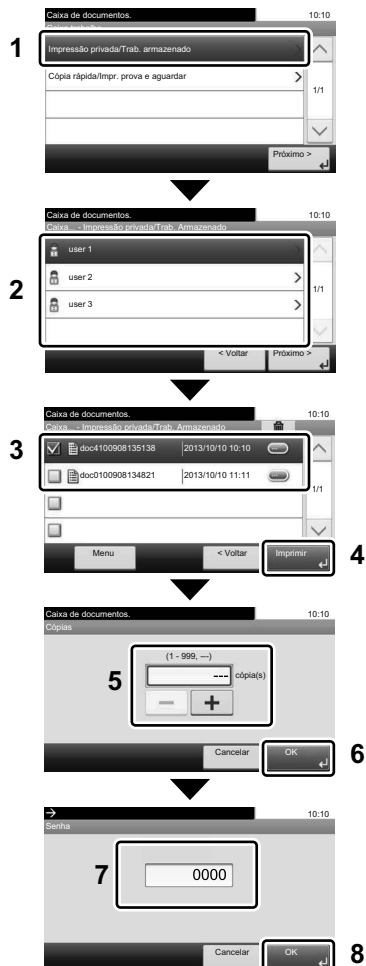

PT-PT

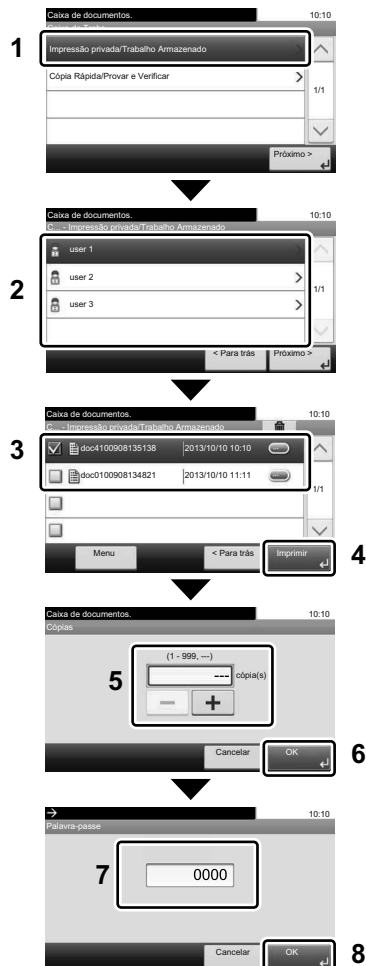

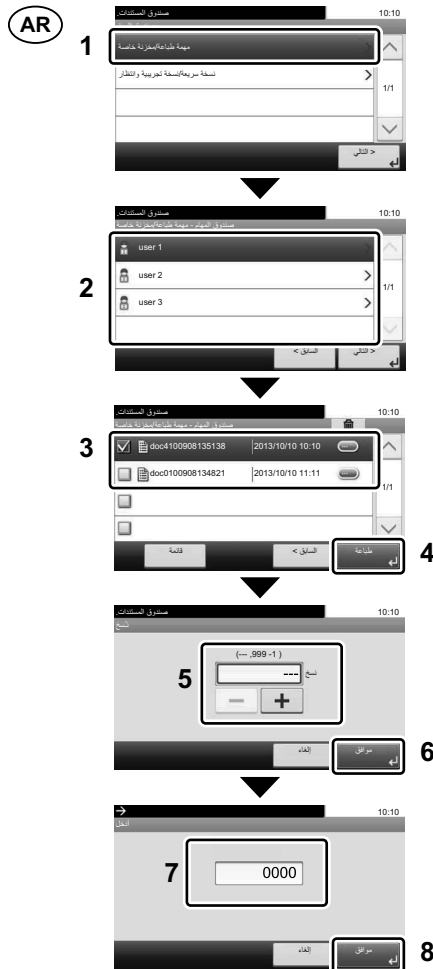
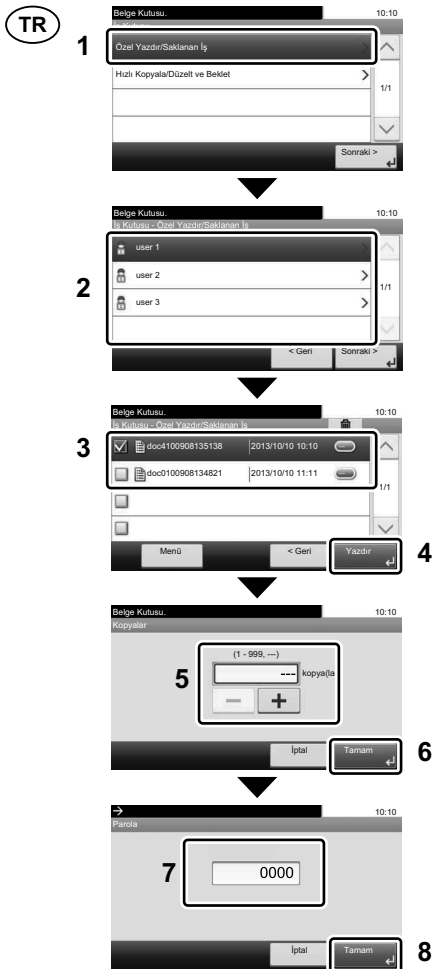
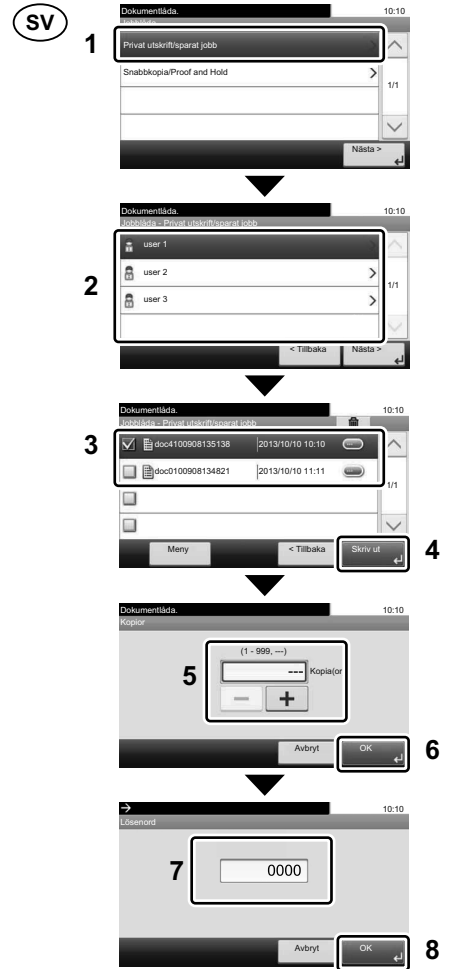
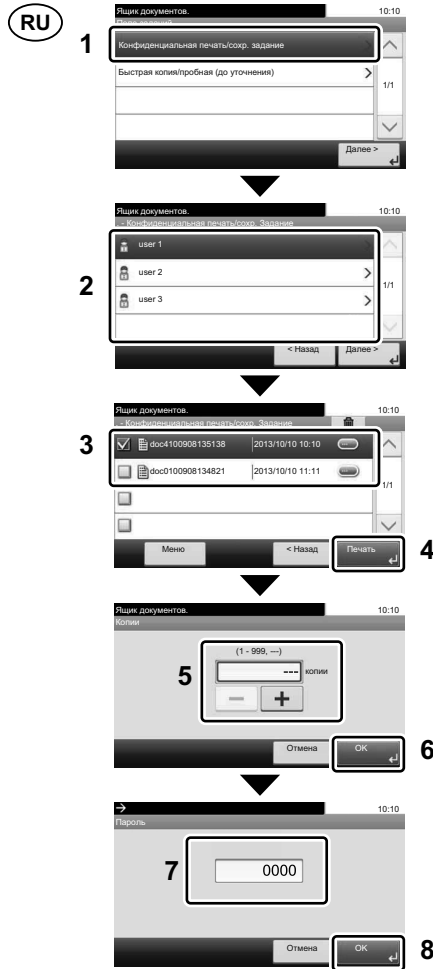
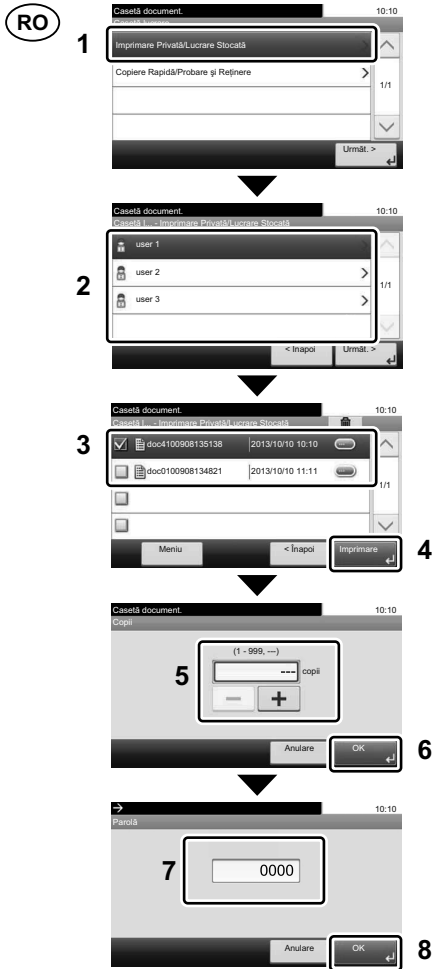

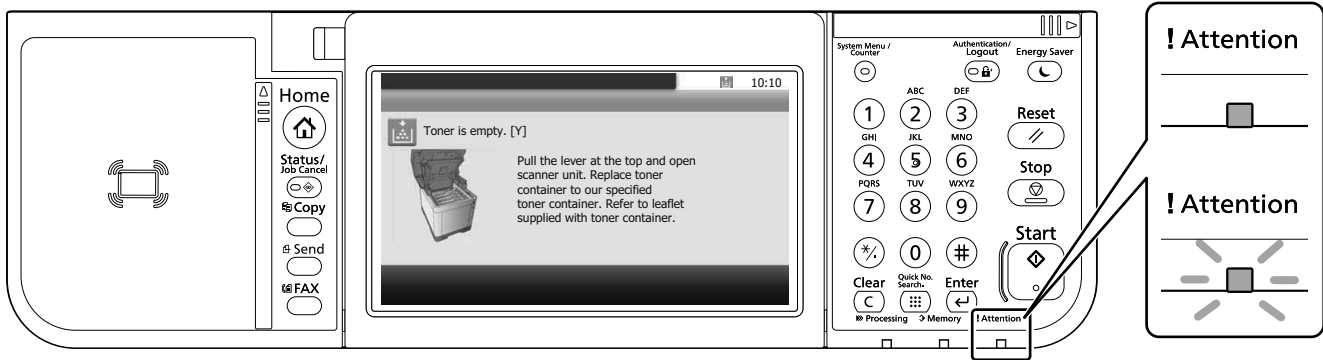

- (EN)** If an error occurs on the machine, the error message appears on the screen. Also the Attention indicator on the operation panel will light up or flash. Follow the instructions on the screen to clear the error. For details, refer to the Operation Guide on the Product Library disc.
- (CA)** Si es produeix un error en el dispositiu, es mostrarà el missatge d'error a la pantalla. També s'il·luminarà o parpellejarà l'indicador "Attention" (Alerta) al tauler d'operacions. Seguiu les instruccions de la pantalla per esborrar l'error. Per obtenir més informació, consulteu la Manual d'instruccions al disc Biblioteca del producte.
- (CS)** Pokud v zařízení dojde k chybě, na obrazovce se objeví chybové hlášení. Indikátor Attention na ovládacím panelu se rozsvítí nebo bude blikat. Pro odstranění chyby se řiďte pokyny na obrazovce. Více podrobností naleznete v návodu k obsluze na disku Product Library.
- (DA)** Hvis der opstår fejl på maskinen, vises fejlmeddelelsen på skærmen. Samtidig vil Attention-lampen på betjeningspanelet lyse eller blinke. Følg instruktionerne på skærmen for at slette fejlen. Se Betjeningsvejledning på Product Library disken for yderligere information.
- (DE)** Falls ein Gerätefehler auftritt, erscheint eine Fehlermeldung in der Anzeige. Außerdem leuchtet oder blinkt die LED "Warnung" auf dem Bedienfeld. Folgen Sie den Anweisungen in der Bildschirmanzeige, um den Fehler zu beseitigen. Weitere Details finden Sie in der Bedienungsanleitung auf dem Product Library Datenträger.
- (EL)** Αν πραγματοποιηθεί σφάλμα στο μηχάνημα, το μήνυμα του σφάλματος εμφανίζεται στην οθόνη. Επίσης, η ενδεικτική λυχνία Attention στον Πίνακα Λειτουργίας θα ανάψει ή θα αναβοσβήσει. Ακολουθήστε τις οδηγίες της οθόνης για να διορθώσετε το σφάλμα. Για λεπτομέρειες, ανατρέξτε στο Εγχειρίδιο Χρήσης στον δίσκο Product Library.
- (ES)** Si se produce un error en la máquina, el mensaje de error aparecerá en la pantalla. Además, el indicador Atención del panel de controles se iluminará o parpadeará. Siga las instrucciones de la pantalla para borrar el error. Para obtener más información, consulte la Guía de uso que está disponible en el disco Product Library.
- (FI)** Jos koneessa on vikatila, ruudulle ilmestyy vikailmoitus. Myös toimintapaneelin Attention -indikaattori syttyy tai vilkkuu. Seuraa ohjeita näytöltä vikatilan poistamiseksi. Löydät yksityiskohtaiset tiedot Tuotekirjastolevyn Käyttöopas.
- (FR)** Si une erreur se produit sur la machine, le message d'erreur s'affiche sur l'écran. De plus, le voyant Attention s'allume ou clignote sur le panneau de commande. Suivre les instructions sur l'écran pour effacer l'erreur. Pour plus de détails, se reporter au manuel d'utilisation sur le disque Product Library.
- (HU)** Ha hiba történik a készüléken, egy hibaüzenet jelenik meg a képernyőn. Emellett az Attention jelzőfény is világít vagy villog a kezelőpanelen. A hiba megszüntetéséhez kövesse a képernyőn megjelenő utasításokat. Részletekért lásd a Product Library lemezen lévő Használati útmutató.
- (IT)** Se sulla macchina si verifica un errore, sullo schermo viene visualizzato un messaggio di errore. Inoltre, l'indicatore Attenzione del pannello comandi si illumina oppure lampeggia. Seguire le istruzioni visualizzate sullo schermo per eliminare l'errore. Per i dettagli, vedere la Guida alle funzioni, reperibile sul disco Product Library.

- NL** Als er een fout optreedt op het apparaat, dan verschijnt de foutmelding op het scherm. Bovendien gaat ook het Opgelet-indicatorlampje op het bedieningspaneel branden of knipperen. Volg de instructies op het scherm om de fout te wissen. Voor meer informatie, raadpleeg de Gebruikershandleiding op de Product Library schijf.
- NO** Hvis det oppstår en feil på maskinen, vises feilmeldingen på skjermen. Også "Attention"-indikatoren på betjeningspanelet vil tennes eller begynne å blinke. Følg instruksjonene på skjermen for å fjerne feilen. For detaljer, se Operatørhåndbok i produktbiblioteket.
- PL** Jeżeli na urządzeniu wystąpi błąd, na wyświetlaczu zostanie wyświetlony komunikat o błędzie. Błąd jest sygnalizowany też zaświeceniem się lub miganiem wskaźnika Attention na panelu operacyjnym. Aby skasować błąd, postępuj zgodnie z instrukcjami wyświetlanymi na ekranie. Więcej informacji można znaleźć w Podręcznik obsługi znajdującej się na dysku Product Library.
- PT-BR** Se ocorrer um erro na máquina, a mensagem de erro aparece na tela. Também o indicador Atenção no painel de operação vai acender ou piscar. Siga as instruções na tela para corrigir o erro. Para obter detalhes, consulte o Guia de Operação no disco Biblioteca do Produto.
- PT-PT** Se ocorrer um erro na máquina, a mensagem de erro surge no ecrã. Além disso, o indicador "Atenção" no painel de operações irá acender ou piscar. Siga as instruções no ecrã para limpar o erro. Para mais informações consulte o Guia de Uso no disco da Biblioteca de Produtos.
- RO** Dacă apare o eroare la aparat, mesajul de eroare apare pe ecran. De asemenea, indicatorul Attention de pe panoul de operare se va lumina sau va clipi. Urmați instrucțiunile de pe ecran pentru a rezolva eroarea. Pentru detalii, consultați Ghid de operare de pe discul Product Library.
- RU** Если в работе аппарата произошла ошибка, на экране появится сообщение об ошибке. Также будет светиться или мигать индикатор Внимание на панели управления. По поводу сброса ошибки см. руководство по эксплуатации. Дополнительная информация приведена в Руководстве по эксплуатации на диске Product Library.
- SV** Om ett fel uppstår på maskinen, visas felmeddelandet på skärmen. Även "Attention"-indikatorn på kontrollpanelen tänds eller blinkar. Följ instruktionerna på skärmen för att ta bort felet. För ytterligare detaljer, konsultera Bruksanvisning som finns på skivan Product Library.
- TR** Makinede bir hata meydana gelirse, hata mesajı ekranda görüntülenir. Ayrıca çalıştırma panelindeki Attention göstergesi yanıp söner veya yanık kalır. Hatayı temizlemek için ekrandaki talimatı takip edin. Ayrıntılar için, Product Library DVD'sindeki Çalıştırma Kılavuzuna bakınız.
- AR** في حالة حدوث خطأ في الجهاز، تظهر رسالة الخطأ على الشاشة. وكذلك يضيء مؤشر Attention على لوحة التشغيل أو يومض. راجع دليل التشغيل للتخلص من الخطأ. للحصول على تفاصيل، راجع دليل التشغيل على قرص Product Library.

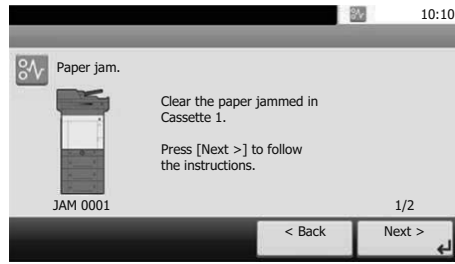

- EN** If paper jam occurs, follow the guidance on the operation panel to remove paper.
- CA** Si s'encalla el paper, seguiu els passos indicats al tauler d'operacions per extraure el paper.
- CS** Pokud uvízne papír, odstraňte jej podle pokynů na provozním panelu.
- DA** Følg anvisningerne på betjeningspanelet for at fjerne papiret, hvis der opstår papirstop.
- DE** Sollte ein Papierstau auftreten, folgen Sie den Anweisungen auf dem Bedienfeld, um das Papier zu entfernen.
- EL** Εάν υπάρξει εμπλοκή χαρτιού, ακολουθήστε τις οδηγίες που εμφανίζονται στον πίνακα λειτουργίας για να αφαιρέσετε το χαρτί.
- ES** Si se produce un atasco de papel, siga las instrucciones del panel de controles para retirar el papel.
- FI** Jos laitteessa on paperitukos, noudata käyttöpaneelin ohjeita poistaaksesi paperin.
- FR** Si un bourrage papier se produit, suivez les conseils du panneau de commande pour retirer le papier.
- HU** Papírelakadás esetén kövesse a kezelőpulton megjelenő utasításokat a papír eltávolításához.
- IT** Se si verifica un inceppamento carta, attenersi alle istruzioni visualizzate sul pannello comandi per rimuovere il foglio.
- NL** Volg bij een papierstoring de aanwijzingen op het bedieningspaneel om het papier te verwijderen.
- NO** Hvis papirstopp oppstår, følg veiledningen på betjeningspanelet for å fjerne papiret.
- PL** W razie zablokowania papieru w urządzeniu wykonaj instrukcje z panelu operacyjnego, aby usunąć papier.
- PT-BR** Se ocorrer um atolamento de papel, siga as orientações no painel de operação para remover o papel.
- PT-PT** Se o papel encravar, siga as orientações no painel de funcionamento para retirar o papel.
- RO** În caz de blocaj de hârtie, urmați instrucțiunile de pe panoul de utilizare pentru a scoate hârtia.
- RU** В случае замятия бумаги извлеките ее, следуя указаниям на панели управления.
- SV** Om ett pappersstopp inträffar tar du bort papperet genom att följa instruktionerna på kontrollpanelen.
- TR** Kâğıt sıkışması meydana gelirse, kâğıdı çıkarmak için işletim panosundaki yol gösterimini izleyin.
- AR** في حالة انحصار الورق، اتبع التوجيهات الموجودة على لوحة التشغيل لإخراج الورق المحشور.

MEMO

MEMO



**QUALITY
CERTIFICATE**

This machine has passed
all quality controls and
final inspection.

