



Document Solutions



> PRINT

ECOSYS P5021cdn  
ECOSYS P5021cdw  
ECOSYS P5026cdn  
ECOSYS P5026cdw

# FIRST STEPS QUICK GUIDE



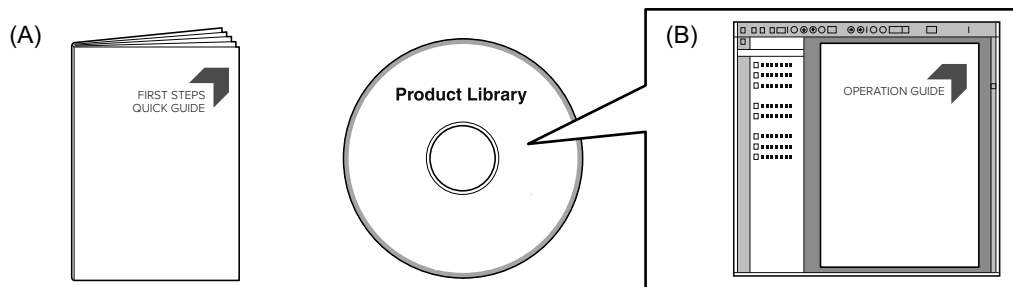

- EN** This guide (A) only explains the basic operations of the machine.  
For other information, see Operation Guide (B) on the Product Library disc.
- CA** En aquesta guia (A) només es descriuen les operacions bàsiques de la màquina. Per obtenir més informació, consulteu la Guia de Funcionament (B) al disc Biblioteca del producte (Product Library).
- CS** Tento průvodce (A) vysvětluje pouze základní obsluhu zařízení.  
Bližší informace naleznete v Návodu k obsluze (B) na disku Product Library.
- DA** Denne vejledning (A) forklarer kun de grundlæggende funktioner af maskinen.  
Andre oplysninger findes i Betjeningsvejledning (B) på Product Library disken.
- DE** Dieser Leitfaden (A) erläutert nur die grundlegende Bedienung des Geräts.  
Für weitere Informationen, siehe Bedienungsanleitung (B) in der Product Library auf dem Datenträger.
- EL** Οι παρούσες οδηγίες (A) επεξηγούν μόνο τις βασικές λειτουργίες του μηχανήματος.  
Για άλλες πληροφορίες, ανατρέξτε στις Οδηγίες χρήσης (B) στο δίσκο Product Library.
- ES** En esta guía (A) solo se explican los procedimientos básicos de la máquina.  
Para obtener otra información, consulte la Guía de uso (B) en el disco Product Library.
- FI** Tässä oppaassa (A) kuvataan vain laitteen perustoiminnot.  
Katso tarkemmat tiedot Product Library -levyn Käyttöopas (B).
- FR** Ce guide (A) explique uniquement les opérations de base de la machine.  
Pour toute autre information, se reporter au Manuel d'utilisation (B) sur le disque Product Library.
- HU** Ez az útmutató (A) csak a készülék alapvető működését ismerteti.  
Bővebb információért lásd a Használati útmutatót (B) a Product Library lemezen.
- IT** Questa guida (A) descrive solo le funzioni base del dispositivo.  
Per ulteriori informazioni, vedere la Guida alle funzioni (B) sul disco Product Library.
- NL** In deze handleiding (A) worden alleen de basisfuncties van de machine beschreven.  
Voor meer informatie, raadpleeg de gebruikershandleiding (B) op de Product Library schijf.
- NO** Denne guide (A) forklarer bare den grunnleggende bruken av maskinen.  
For annen informasjon, se Operatørhåndbok (B) i Product Library platen.

**PL** Niniejszy podręcznik (A) objaśnia jedynie podstawowe sposoby używania urządzenia.  
Więcej informacji można znaleźć w Podręczniku Obsługi (B) lub na dysku Product Library.

**PT-BR** Este guia (A) somente explica as operações básicas da máquina.  
Para obter outras informações, consulte o Guia de Operação (B) no disco Product Library.

**PT-PT** Este guia (A) explica apenas as operações básicas da máquina.  
Para obter mais informações, consulte o Guia de Operação (B) no disco Product Library.

**RO** Acest ghid (A) explică doar operațiunile de bază ale aparatului.  
Pentru alte informații, consultați Ghidul de Operare (B) de pe discul Product Library.

**RU** В данном руководстве (A) описаны только основные операции с устройством.  
Дополнительные сведения см. в руководстве по эксплуатации (B) на диске Product Library.

**SV** I den här guiden (A) förklaras endast maskinens grundfunktioner.  
För annan information hänvisas till bruksanvisningen (B) på skivan Product Library.

**TR** Bu kılavuz (A) sadece makinenin temel işlemlerini açıklar.  
Diğer bilgiler için, Product Library diskindeki Çalıştırma Kılavuzuna (B) bakınız.

**AR** هذا الدليل (A) يشرح فقط عمليات تشغيل الجهاز الأساسية.  
لمزيد من المعلومات، راجع دليل التشغيل (B) الموجود على قرص Product Library.

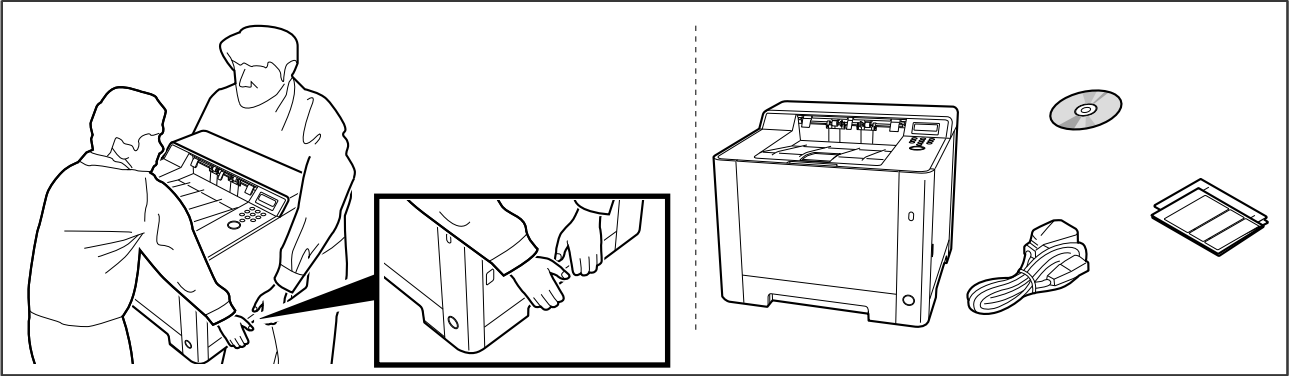

- Ⓔ EN The included components differ depending on the countries or regions.
- Ⓕ CA Els components que s'hi inclouen poden variar en funció dels països o de les regions.
- Ⓖ CS Přiložené součásti se mohou lišit v závislosti na zemích nebo oblastech.
- Ⓓ DA De medfølgende komponenter varierer afhængigt af land eller region.
- Ⓗ DE Je nach Land oder Region sind im Lieferumfang andere Komponenten enthalten.
- Ⓔ EL Τα εξαρτήματα που περιλαμβάνονται ενδέχεται να διαφέρουν ανάλογα με τη χώρα ή την περιοχή.
- Ⓔ ES Los componentes facilitados varían en función de los países o regiones.
- Ⓕ FI Pakkaukseen kuuluvat osat vaihtelevat maan ja alueen mukaan.
- Ⓕ FR Les composants inclus varient en fonction des pays ou régions.
- Ⓕ HU A mellékelt alkatrészek országtól vagy régiótól függően változók.
- Ⓕ IT I componenti inclusi sono differenti a seconda del paese o della zona geografica.
- Ⓕ NL De meegeleverde onderdelen verschillen volgens het land of de regio.
- Ⓕ NO De medfølgende komponentene varierer avhengig av land eller region.
- Ⓕ PL Dołączone do urządzenia wyposażenie może różnić się w zależności od kraju lub regionu.
- Ⓕ PT-BR Os componentes incluídos variam conforme os países ou as regiões.
- Ⓕ PT-PT Os componentes incluídos variam consoante os países ou regiões.
- Ⓕ RO Componentele incluse diferă în funcție de țară sau regiune.
- Ⓕ RU Комплектация компонентами зависит от страны или региона.
- Ⓕ SV De medföljande komponenterna varierar i olika länder och regioner.
- Ⓕ TR Ürünle birlikte verilen parçalar ülkeye veya bölgeye göre değişir.
- Ⓕ AR تختلف المكونات المضمنة باختلاف البلاد أو المناطق.

## C Setting up the Toner Container

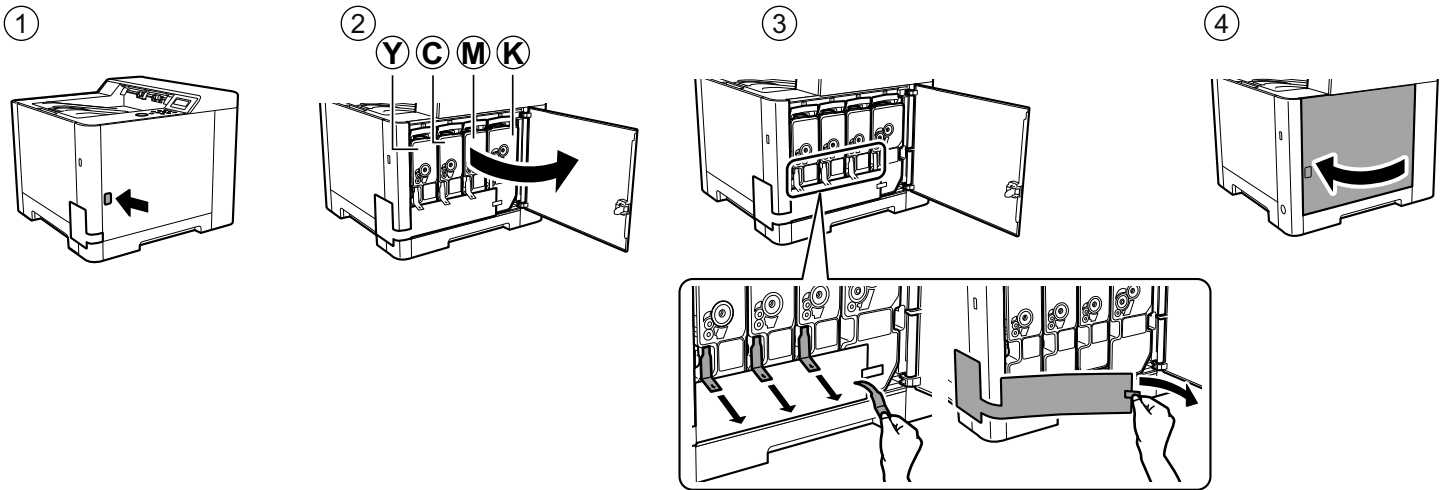

## D Connect Cable

### Network

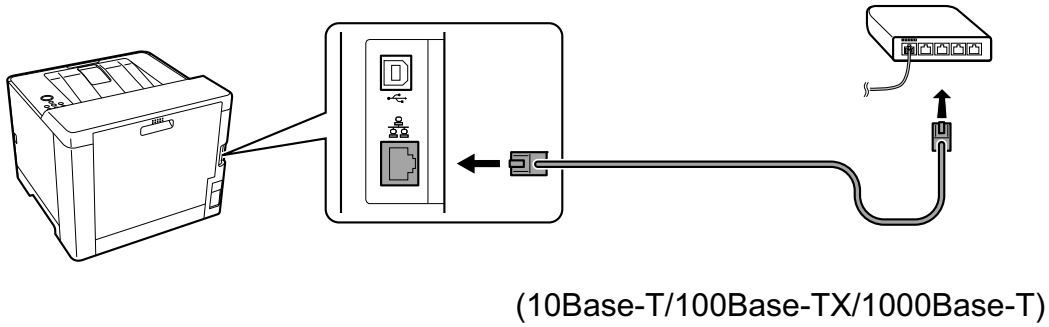

### USB

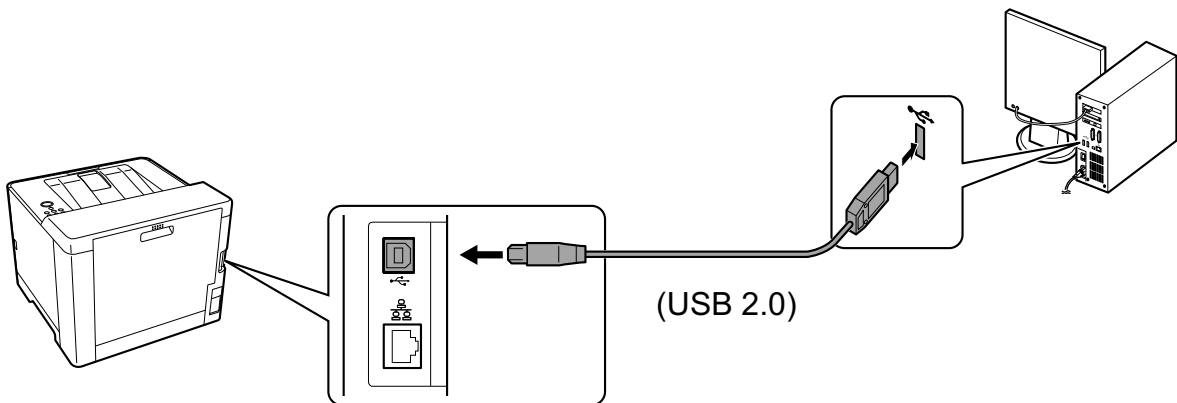

## E Loading Paper

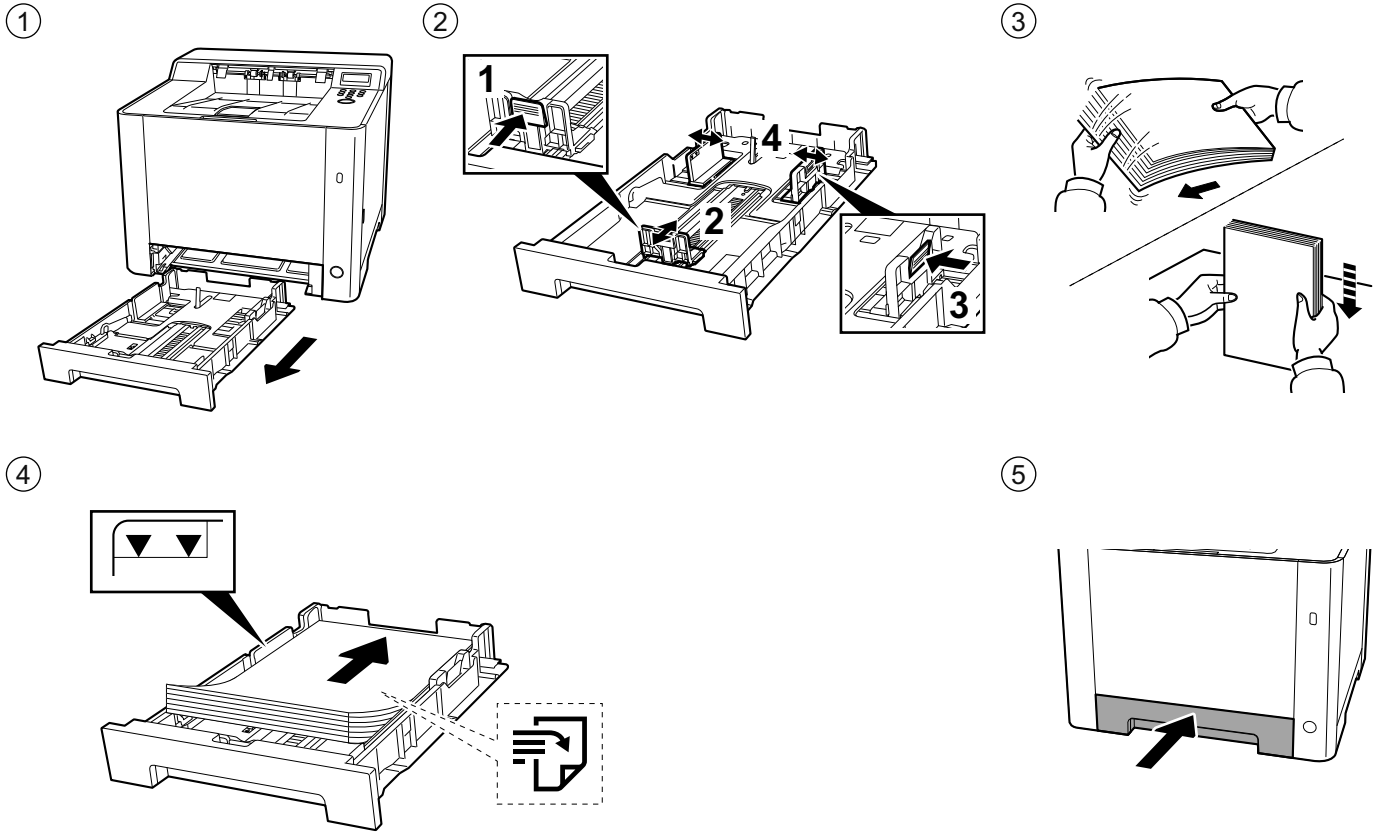

## F Connect Power Cord

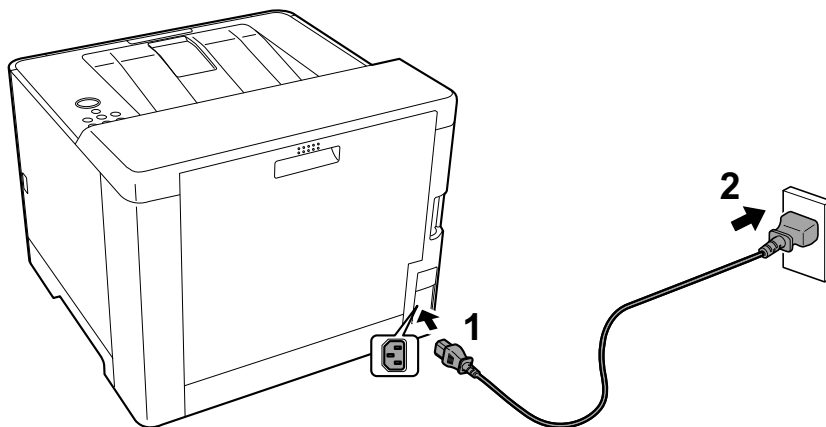

**G** Replace Operation Panel Sheet

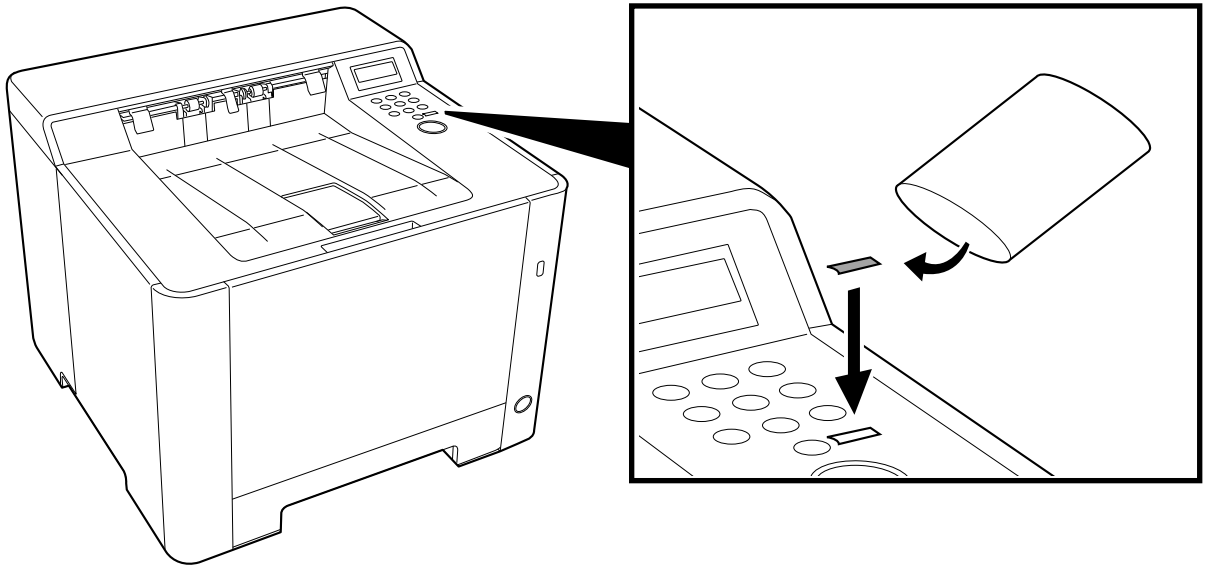

**H** Power On

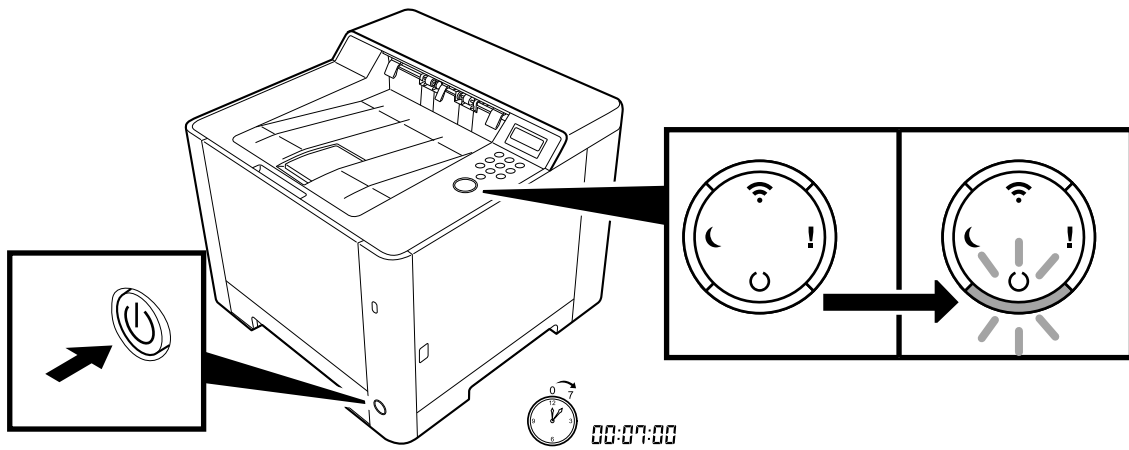



# Altitude Adjustment (1000m or higher Only)

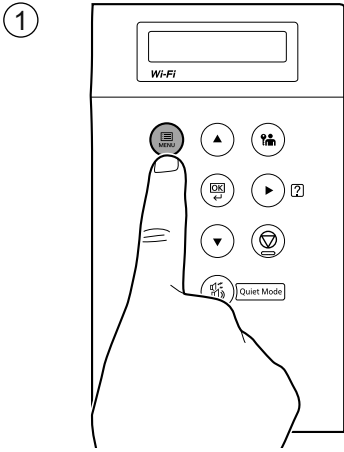

②

EN

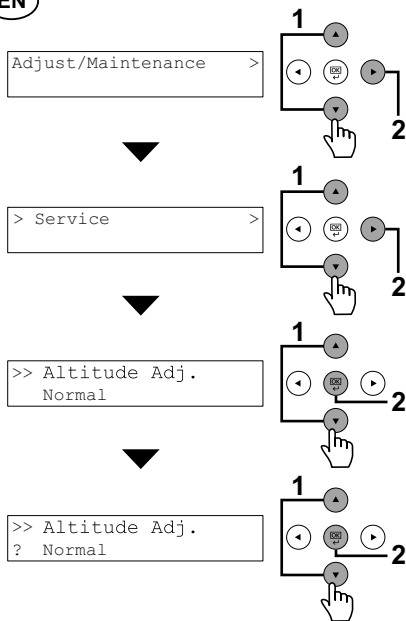

ES

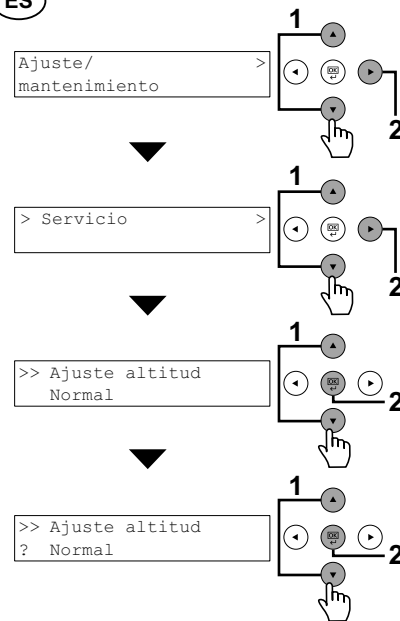

FR

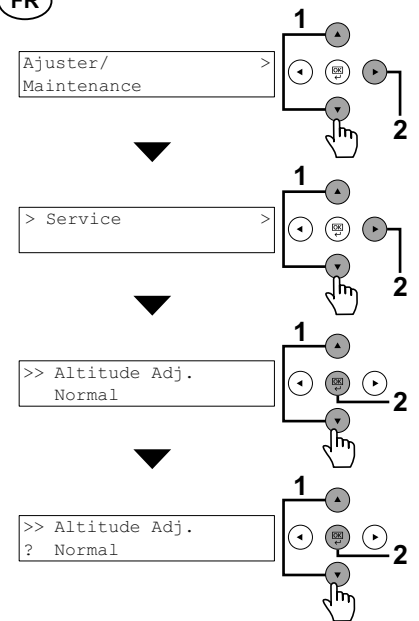

PT-BR

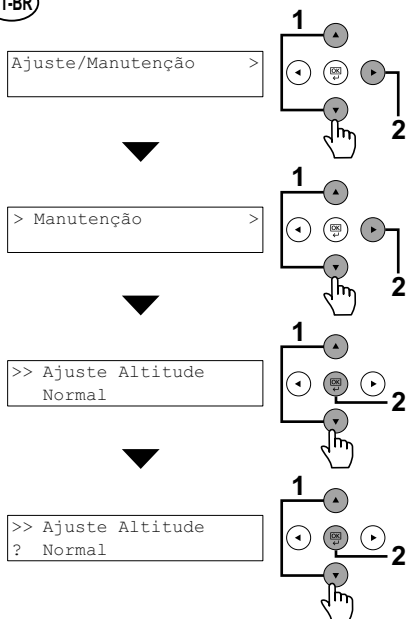

# J Print Status Page

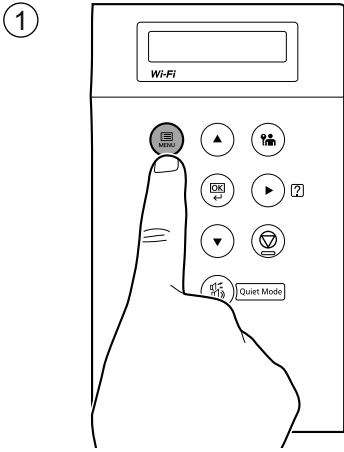

②

EN

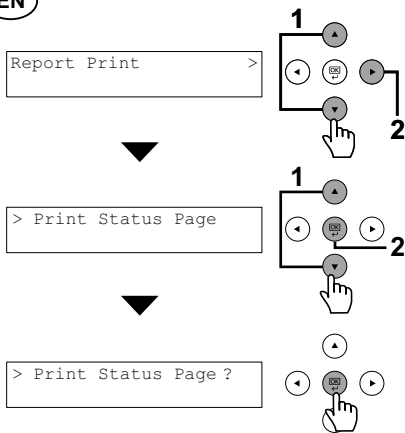

CA

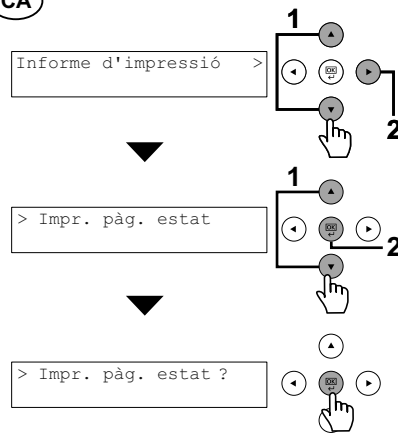

CS

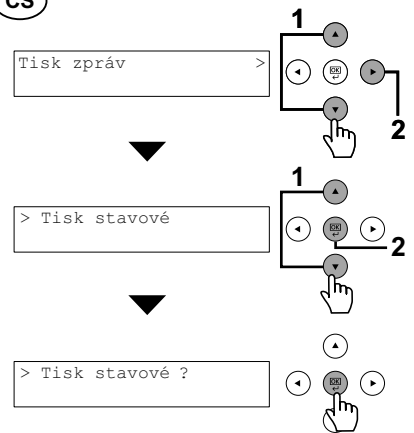

DA

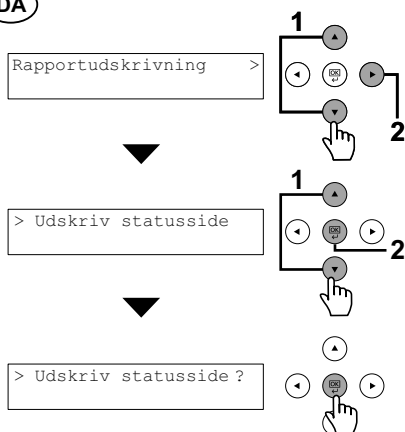

DE

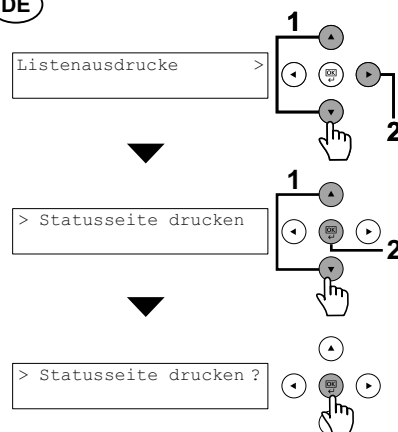

EL

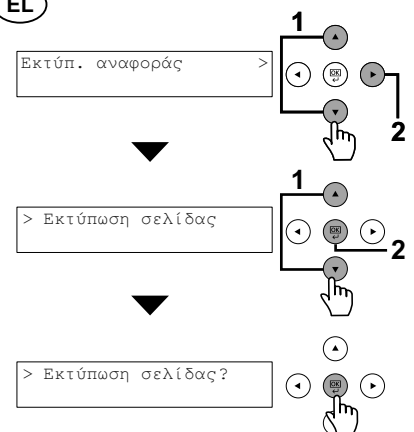

ES

Imprimir informe >



> Imprimir



> Imprimir ?

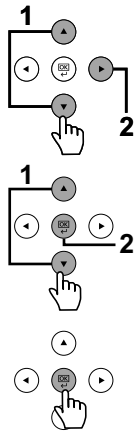

FI

Raportin tulostus >



> Tulosta tilasivu



> Tulosta tilasivu?

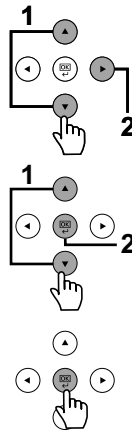

FR

Imprimer Rapport >



> Impression



> Impression ?

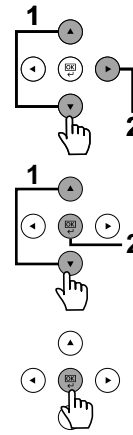

HU

Jelentés nyomt. >



> Állapotlap



> Állapotlap ?

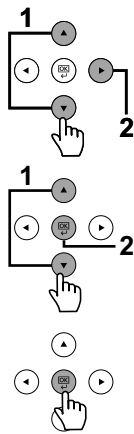

IT

Stampa rapporto >



> Tulosta tilasivu



> Tulosta tilasivu?

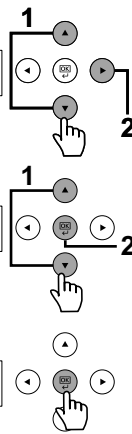

NL

Rapport afgedruken >



> Statuspagina



> Statuspagina ?

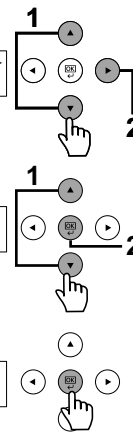

NO

Rapportutskrift >



> Skriv ut statusside



> Skriv ut statusside?

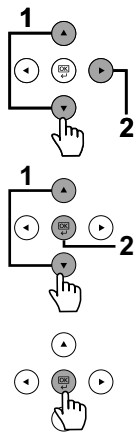

PL

Wydruk raportu >



> Drukuj stronę



> Drukuj stronę ?

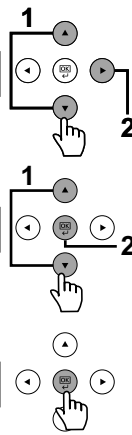

PT-BR

Imprimir Relatório >



> Imprimir Página



> Imprimir Página ?

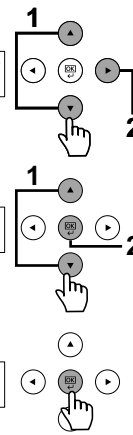

PT-PT

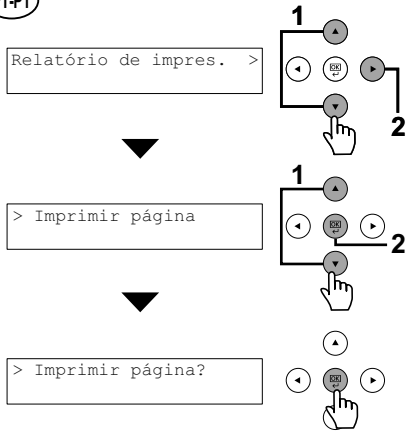

RO

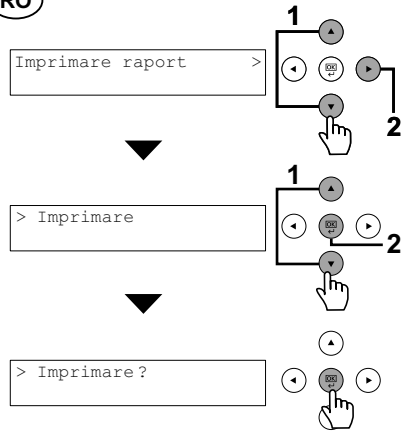

RU

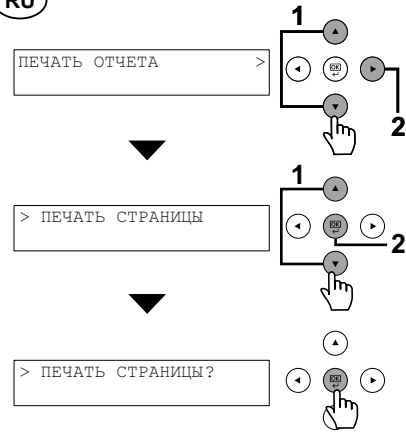

SV

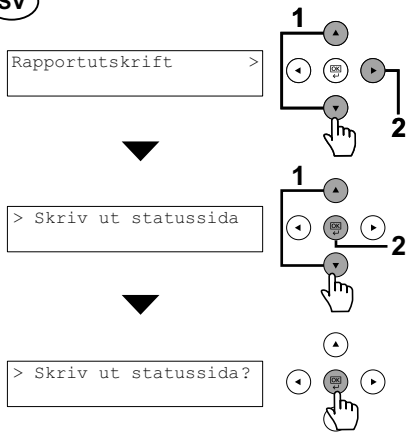

TR

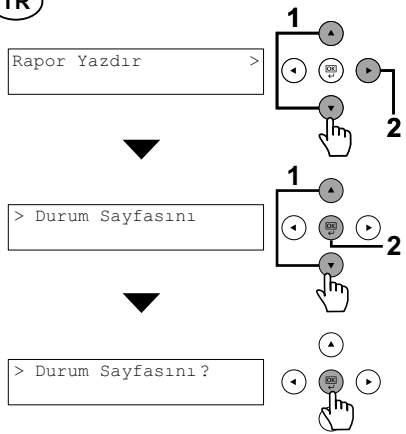

AR

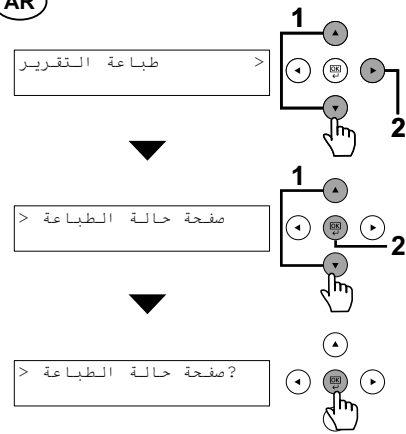

## K Install Drivers and Utilities

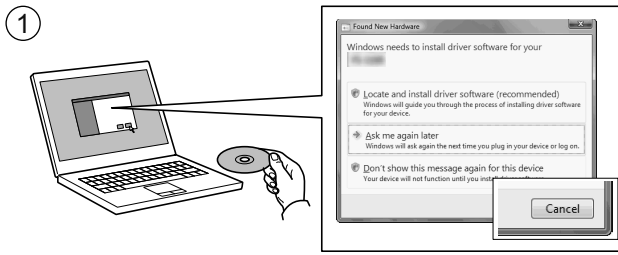

- EN** If Found new Hardware window appears, click Cancel.
- CA** Si es mostra la finestra "Found new Hardware" (S'ha detectat maquinari nou), feu clic a Cancel·la.
- CS** Pokud se zobrazí dialogové okno Nalezen nový hardware, klepněte na tlačítko Storno.
- DA** Vælg Annuller, hvis dialogboksen Der er fundet ny hardware.
- DE** Bitte legen Sie die beiliegende CD ein und folgen Sie den Anweisungen am Bildschirm, falls auf dem Bildschirm die Anzeige 'Neue Hardware gefunden' von Windows erscheint, drücken Sie Abbrechen.
- EL** Αν εμφανιστεί το παράθυρο Εύρεση νέου υλικού, κάντε κλικ στο κουμπί Άκυρο.
- ES** Si aparece la ventana Nuevo hardware encontrado, haga clic en Cancelar.
- FI** Jos näkyyiin tulee Uusi laite löydetty -ikkuna, napsauta Peruuta.
- FR** Si la fenêtre Nouveau matériel détecté s'affiche, cliquez sur Annuler.
- HU** Ha az Új hardver telepítési ablak megjelenik, kattintson a Mégse gombra.
- IT** Se compare la finestra Trovato nuovo hardware, fare clic su Annulla.
- NL** Als het dialoogvenster nieuwe hardware gevonden verschijnt, selecteert u Annuleren.
- NO** Hvis vinduet Ny maskinvare funnet vises, klikk på Avbryt.
- PL** Jeżeli wyświetlone zostanie okno Znaleziono nowy sprzęt, należy kliknąć przycisk Anuluj.
- PT-BR** Se a janela Um novo Hardware foi encontrado aparecer, clique em Cancelar.
- PT-PT** Se a janela Encontrar Novo Hardware aparecer, clique em Cancelar.
- RO** Dacă apare fereastra Found New Hardware, faceți clic pe Cancel.
- RU** Если появляется окно Найдено новое аппаратное обеспечение, щелкните Отменить.
- SV** Om Dialogfönstret visar 'Hittade ny hårdvara' klicka då på Avbryt.
- TR** Yeni Donanım Bulundu penceresi görüntülenirse, İptal'i tıklatın.
- AR** إذا ظهرت نافذة تم العثور على جهاز جديد ، انقر على إلغاء.

2

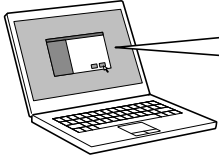

- EN** Follow the instructions in the installation wizard.
- CA** Seguiu les instruccions de l'auxiliar d'instal·lació.
- CS** Řiďte se pokyny v průvodci instalací.
- DA** Følg instruktionerne i installationsguiden.
- DE** Folgen Sie den Anweisungen des Schnelleinstellung Assistenten.
- EL** Ακολουθήστε τις οδηγίες στον οδηγό εγκατάστασης.
- ES** Siga las instrucciones del asistente de instalación.
- FI** Noudata asennusohjelman ohjeita.
- FR** Suivre les instructions de l'assistant d'installation.
- HU** Kövesse a telepítő varázsló utasításait.
- IT** Attenersi alle istruzioni della procedura guidata di installazione.
- NL** Volg de instructies in de installatiewizard.
- NO** Følg instruksjonene i installasjonsveiledningen.
- PL** Postępuj zgodnie z instrukcjami wyświetlanymi w oknie kreatora instalacji.
- PT-BR** Siga as instruções no assistente de instalação.
- PT-PT** Siga as instruções no assistente de instalação.
- RO** Urmați instrucțiunile expertului de instalare.
- RU** Следуйте инструкциям в окне мастера установки.
- SV** Följ anvisningarna i installationsguiden.
- TR** Kurulum sihirbazındaki talimatları izleyiniz.
- AR** اتبع تعليمات معالج التثبيت.



- EN** Admin. ID: ECOSYS P5026cdw/ECOSYS P5026cdn - 2600  
ECOSYS P5021cdw/ECOSYS P5021cdn - 2100  
Admin. Password: ECOSYS P5026cdw/ECOSYS P5026cdn - 2600  
ECOSYS P5021cdw/ECOSYS P5021cdn - 2100
- CA** Admin. ID: ECOSYS P5026cdw/ECOSYS P5026cdn - 2600  
ECOSYS P5021cdw/ECOSYS P5021cdn - 2100  
Admin. Password: ECOSYS P5026cdw/ECOSYS P5026cdn - 2600  
ECOSYS P5021cdw/ECOSYS P5021cdn - 2100
- CS** Admin. ID: ECOSYS P5026cdw/ECOSYS P5026cdn - 2600  
ECOSYS P5021cdw/ECOSYS P5021cdn - 2100  
Admin. Heslo: ECOSYS P5026cdw/ECOSYS P5026cdn - 2600  
ECOSYS P5021cdw/ECOSYS P5021cdn - 2100
- DA** Admin. ID: ECOSYS P5026cdw/ECOSYS P5026cdn - 2600  
ECOSYS P5021cdw/ECOSYS P5021cdn - 2100  
Admin. Password: ECOSYS P5026cdw/ECOSYS P5026cdn - 2600  
ECOSYS P5021cdw/ECOSYS P5021cdn - 2100
- DE** Admin. ID: ECOSYS P5026cdw/ECOSYS P5026cdn - 2600  
ECOSYS P5021cdw/ECOSYS P5021cdn - 2100  
Admin. Passwort: ECOSYS P5026cdw/ECOSYS P5026cdn - 2600  
ECOSYS P5021cdw/ECOSYS P5021cdn - 2100
- EL** ID Διαχ.: ECOSYS P5026cdw/ECOSYS P5026cdn - 2600  
ECOSYS P5021cdw/ECOSYS P5021cdn - 2100  
Κωδικός διαχ.: ECOSYS P5026cdw/ECOSYS P5026cdn - 2600  
ECOSYS P5021cdw/ECOSYS P5021cdn - 2100
- ES** ID. admin.: ECOSYS P5026cdw/ECOSYS P5026cdn - 2600  
ECOSYS P5021cdw/ECOSYS P5021cdn - 2100  
Contras. admin.: ECOSYS P5026cdw/ECOSYS P5026cdn - 2600  
ECOSYS P5021cdw/ECOSYS P5021cdn - 2100
- FI** Hall. ID: ECOSYS P5026cdw/ECOSYS P5026cdn - 2600  
ECOSYS P5021cdw/ECOSYS P5021cdn - 2100  
Hall. Salasana: ECOSYS P5026cdw/ECOSYS P5026cdn - 2600  
ECOSYS P5021cdw/ECOSYS P5021cdn - 2100
- FR** ID admin.: ECOSYS P5026cdw/ECOSYS P5026cdn - 2600  
ECOSYS P5021cdw/ECOSYS P5021cdn - 2100  
Mot de passe adm: ECOSYS P5026cdw/ECOSYS P5026cdn - 2600  
ECOSYS P5021cdw/ECOSYS P5021cdn - 2100
- HU** Admin. azonosító: ECOSYS P5026cdw/ECOSYS P5026cdn - 2600  
ECOSYS P5021cdw/ECOSYS P5021cdn - 2100  
Admin. jelszó: ECOSYS P5026cdw/ECOSYS P5026cdn - 2600  
ECOSYS P5021cdw/ECOSYS P5021cdn - 2100
- IT** ID ammin.: ECOSYS P5026cdw/ECOSYS P5026cdn - 2600  
ECOSYS P5021cdw/ECOSYS P5021cdn - 2100  
Password Ammin.: ECOSYS P5026cdw/ECOSYS P5026cdn - 2600  
ECOSYS P5021cdw/ECOSYS P5021cdn - 2100
- NL** Admin. ID: ECOSYS P5026cdw/ECOSYS P5026cdn - 2600  
ECOSYS P5021cdw/ECOSYS P5021cdn - 2100  
Admin wachtwoord: ECOSYS P5026cdw/ECOSYS P5026cdn - 2600  
ECOSYS P5021cdw/ECOSYS P5021cdn - 2100
- NO** Admin-ID: ECOSYS P5026cdw/ECOSYS P5026cdn - 2600  
ECOSYS P5021cdw/ECOSYS P5021cdn - 2100  
Admin-passord: ECOSYS P5026cdw/ECOSYS P5026cdn - 2600  
ECOSYS P5021cdw/ECOSYS P5021cdn - 2100
- PL** ID admin.: ECOSYS P5026cdw/ECOSYS P5026cdn - 2600  
ECOSYS P5021cdw/ECOSYS P5021cdn - 2100  
Hasło admin.: ECOSYS P5026cdw/ECOSYS P5026cdn - 2600  
ECOSYS P5021cdw/ECOSYS P5021cdn - 2100
- PT-BR** ID admin.: ECOSYS P5026cdw/ECOSYS P5026cdn - 2600  
ECOSYS P5021cdw/ECOSYS P5021cdn - 2100  
Senha admin.: ECOSYS P5026cdw/ECOSYS P5026cdn - 2600  
ECOSYS P5021cdw/ECOSYS P5021cdn - 2100
- PT-PT** ID do Admin.: ECOSYS P5026cdw/ECOSYS P5026cdn - 2600  
ECOSYS P5021cdw/ECOSYS P5021cdn - 2100  
Admin. Password: ECOSYS P5026cdw/ECOSYS P5026cdn - 2600  
ECOSYS P5021cdw/ECOSYS P5021cdn - 2100
- RO** ID admin: ECOSYS P5026cdw/ECOSYS P5026cdn - 2600  
ECOSYS P5021cdw/ECOSYS P5021cdn - 2100  
Parolă admin.: ECOSYS P5026cdw/ECOSYS P5026cdn - 2600  
ECOSYS P5021cdw/ECOSYS P5021cdn - 2100
- RU** Идент. админ.: ECOSYS P5026cdw/ECOSYS P5026cdn - 2600  
ECOSYS P5021cdw/ECOSYS P5021cdn - 2100  
Пароль админ.: ECOSYS P5026cdw/ECOSYS P5026cdn - 2600  
ECOSYS P5021cdw/ECOSYS P5021cdn - 2100
- SV** Admin. ID: ECOSYS P5026cdw/ECOSYS P5026cdn - 2600  
ECOSYS P5021cdw/ECOSYS P5021cdn - 2100  
Admin. lösenord: ECOSYS P5026cdw/ECOSYS P5026cdn - 2600  
ECOSYS P5021cdw/ECOSYS P5021cdn - 2100
- TR** Yön. ID: ECOSYS P5026cdw/ECOSYS P5026cdn - 2600  
ECOSYS P5021cdw/ECOSYS P5021cdn - 2100  
Yön. Parolası: ECOSYS P5026cdw/ECOSYS P5026cdn - 2600  
ECOSYS P5021cdw/ECOSYS P5021cdn - 2100
- AR** ECOSYS P5026cdw/ECOSYS P5026cdn - 2600 : رقم هوية المسؤول  
ECOSYS P5021cdw/ECOSYS P5021cdn - 2100  
ECOSYS P5026cdw/ECOSYS P5026cdn - 2600 : كلمة مرور مسؤول  
ECOSYS P5021cdw/ECOSYS P5021cdn - 2100

1

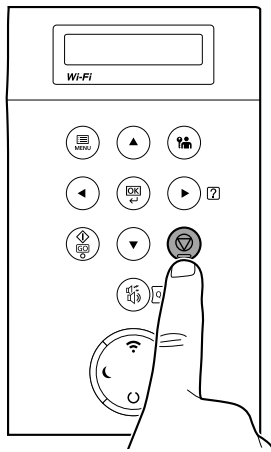

2

EN

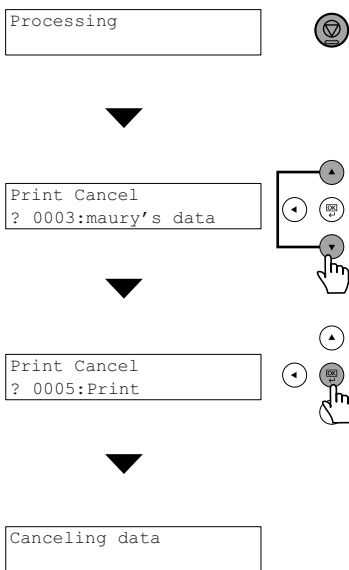

CA

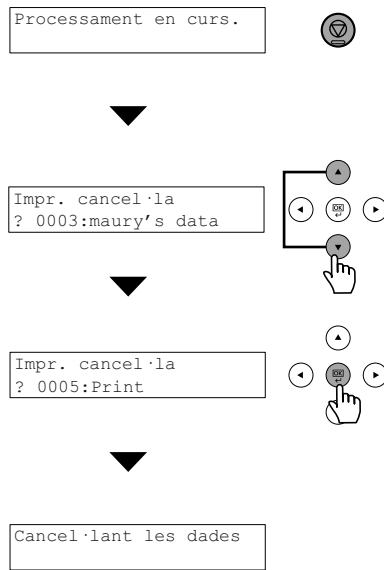

CS

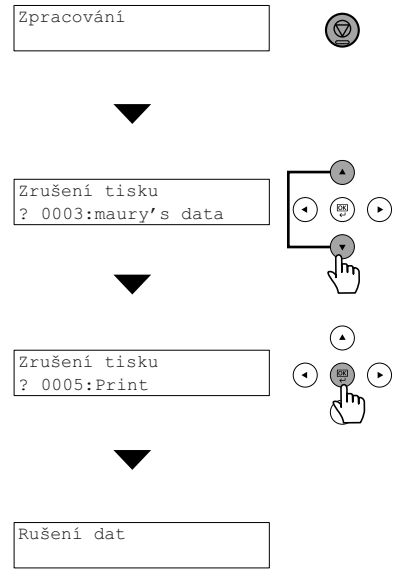

DA

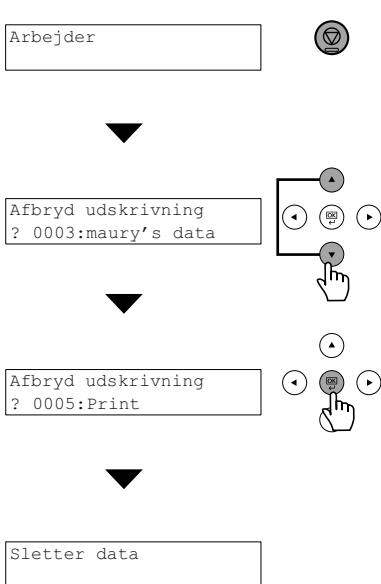

DE

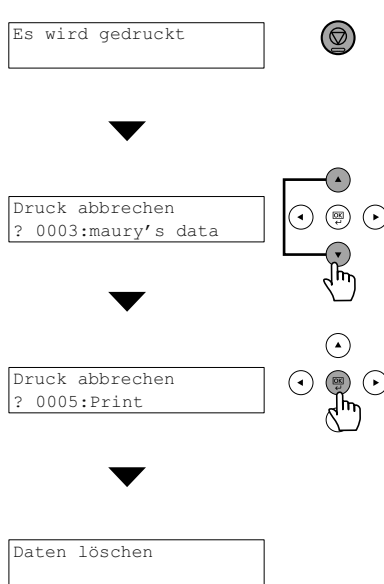

EL

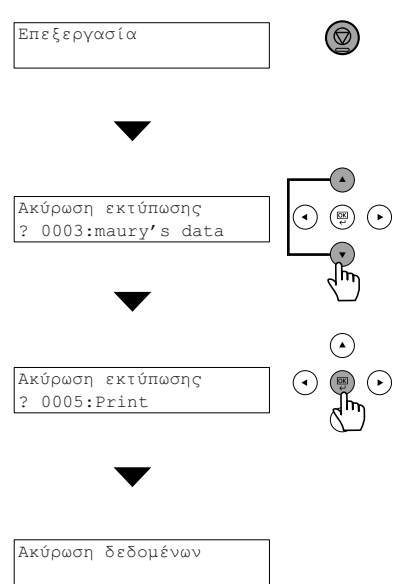



ES

En proceso



Cancelar impresión  
? 0003:maury's data

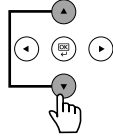

Cancelar impresión  
? 0005:Print

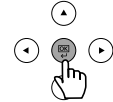

Cancelando datos

FI

Käsittellään



Tulostuksen peruutus  
? 0003:maury's data

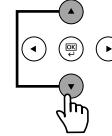

Tulostuksen peruutus  
? 0005:Print

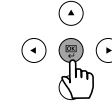

Peruutetaan data

FR

En traitement



Annulation Impression  
? 0003:maury's data

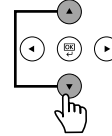

Annulation Impression  
? 0005:Print

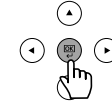

Supprimer data

HU

Feldolgozás



Nyomatás törlése  
? 0003:maury's data

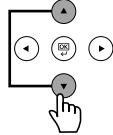

Nyomatás törlése  
? 0005:Print

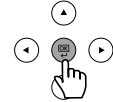

Adatok törlése

IT

Elaborazione



Annullare la stampa  
? 0003:maury's data

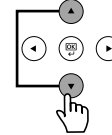

Annullare la stampa  
? 0005:Print

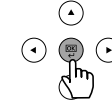

Interruzione stampa

NL

Bezig m verwerkn



Afdruk annuleren  
? 0003:maury's data

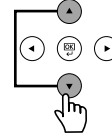

Afdruk annuleren  
? 0005:Print

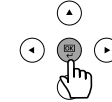

Data worden gewist

NO

Behandler



Avbryt utskrift  
? 0003:maury's data

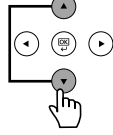

Avbryt utskrift  
? 0005:Print

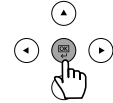

Sletter data

PL

Przetwarzanie



Skasuj wydruk  
? 0003:maury's data

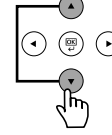

Skasuj wydruk  
? 0005:Print

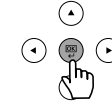

Kasowanie danych

PT-BR

Processando



Cancelar impressão  
? 0003:maury's data

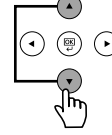

Cancelar impressão  
? 0005:Print

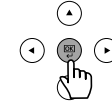

Cancelando dados

PT-PT

A processar



Cancelar impressão  
? 0003:maury's data

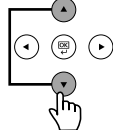

Cancelar impressão  
? 0005:Print

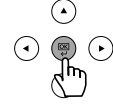

A cancelar dados

RO

Procesare



Anulare imprimare  
? 0003:maury's data

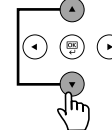

Anulare imprimare  
? 0005:Print

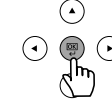

Se anulează date

RU

ОБРАБОТКА



ОТМЕНА ПЕЧАТИ  
? 0003:maury's data

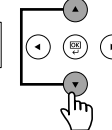

ОТМЕНА ПЕЧАТИ  
? 0005:Print

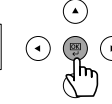

СВРОС ДАННЫХ

SV

Bearbetar



Avbryt utskrift  
? 0003:maury's data

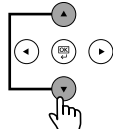

Avbryt utskrift  
? 0005:Print

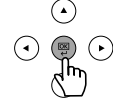

Tar bort data

TR

İşleniyor



Yazdırma İptal  
? 0003:maury's data

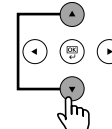

Yazdırma İptal  
? 0005:Print

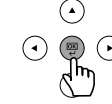

Veri iptali

AR

معالجة



إلغاء الطباعة  
?:0003maury's data

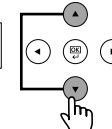

إلغاء الطباعة  
?:0005Print

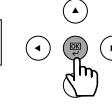

إلغاء بيانات

## From a PC

①

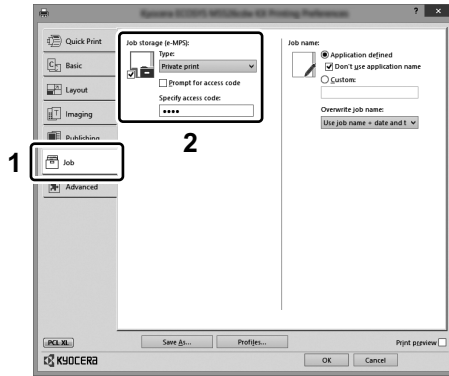

- ① EN To activate the private printing from the PC, set the items No. 1 and 2 in the screen.
- ① CA Per activar la impressió privada des d'un PC, configureu els elements núm. 1 i núm. 2 de la pantalla.
- ① CS Pro aktivaci soukromého tisku z počítače vyberte položku č.1 a 2 na obrazovce.
- ① DA For at aktivere privat udskrivning fra pc'en, indstilles enheder nr. 1 og 2 på skærmen.
- ① DE Um den privaten Druck vom PC aus zu aktivieren, stellen Sie die Punkte 1 und 2 am Bildschirm ein.
- ① EL Για να ενεργοποιήσετε την ιδιωτική εκτύπωση από τον υπολογιστή, ορίστε τα στοιχεία Αρ. 1 και 2 στην οθόνη.
- ① ES Para activar la impresión privada desde el PC, configure los elementos número 1 y 2 en la pantalla.
- ① FI Aktivoidaksesi yksityisen tulostuksen PC:ltä, aseta tiedot nro 1 ja 2 ruudulla.
- ① FR Pour activer l'impression privée à partir de l'ordinateur, définir les éléments 1 et 2 sur l'écran.
- ① HU A magán nyomtatás számítógépről történő aktiváláshoz a képernyőn állítsa be az 1. és a 2. tételt.
- ① IT Per attivare la stampa privata da PC, configurare le voci N. 1 e N. 2 sulla schermata.
- ① NL Om privé afdrucken vanaf de pc te activeren, stel de items nummer 1 en 2 op het scherm in.
- ① NO For å aktivere privat utskrift fra PC, sett element nr. 1 og 2 på skjermen.
- ① PL Aby aktywować drukowanie prywatne z poziomu komputera, skonfiguruj ustawienia oznaczone cyframi 1 i 2 na tym ekranie.
- ① PT-BR Para ativar a impressão privada no PC, defina os itens N. 1 e 2 na tela.
- ① PT-PT Para activar a impressão privada no PC, configure os itens n.º 1 e 2 no ecrã.
- ① RO Pentru a activa imprimarea privată de la PC, setați elementele 1 și 2 de pe ecran.
- ① RU Для активации конфиденциальной печати с ПК выполните настройку пунктов 1 и 2 на экране.
- ① SV För att aktivera funktionen privat utskrift från PC:n, ställ in uppgifterna nr 1 och 2 på skärmen.
- ① TR PC'den özel yazdırma işlemini aktive etmek için, ekranda madde No.1 ve 2'yi ayarlayın.
- ① AR لتشغيل الطباعة الشخصية من جهاز الكمبيوتر، عين العنصرين رقم 1 و 2 في الشاشة.

---

## From the Operation Panel

①

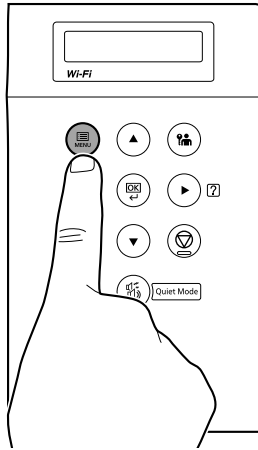

2

EN

Job Box >

> Private/Stored

> Private/Stored  
? User 01

> User 01  
? Data 01

> Data 01  
ID 0000

> Data 01  
Copies 000

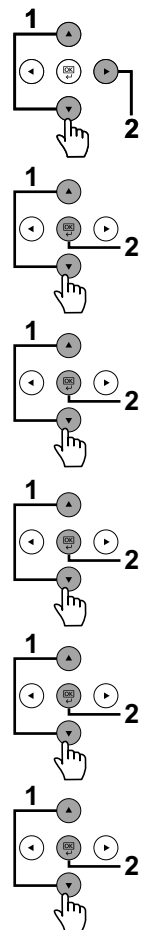

CA

Casella treball >

> Privat/Desat

> Privat/Desat  
? User 01

> User 01  
? Data 01

> Data 01  
Identificador 0000

> Data 01  
Còpies 000

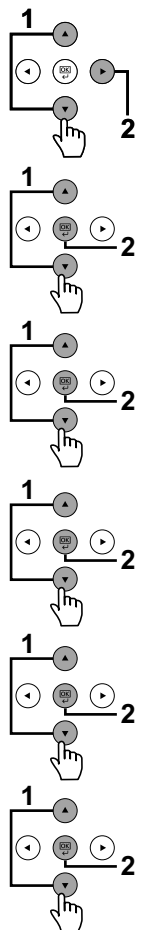

CS

Seznam úloh >

> Soukromý/uložený

> Soukromý/uložený  
? User 01

> User 01  
? Data 01

> Data 01  
ID 0000

> Data 01  
Kopie 000

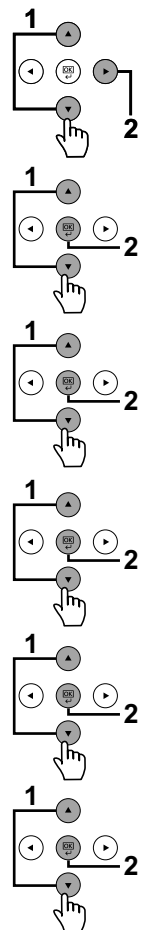

DA

Jobboks >

> Privat/lagret

> Privat/lagret  
? User 01

> User 01  
? Data 01

> Data 01  
Id 0000

> Data 01  
Kopier 000

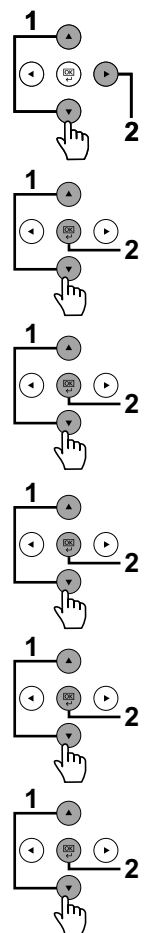

DE

Auftragsbox >

> Privat/Gespeichert

> Privat/Gespeichert  
? User 01

> User 01  
? Data 01

> Data 01  
ID 0000

> Data 01  
Kopien 000

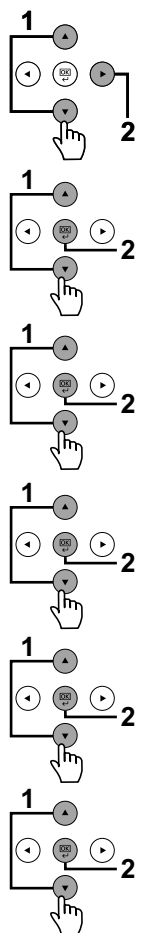

EL

Θυρίδα εργασίας >

> Ιδιωτικό/Αποθηκ.

> Ιδιωτικό/Αποθηκ.  
? User 01

> User 01  
? Data 01

> Data 01  
ID 0000

> Data 01  
Αντίγραφα 000

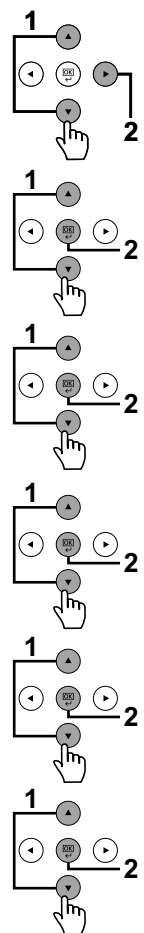

ES

Buzón de trabajos >

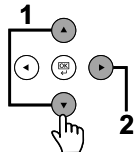

> Privado/Guardado

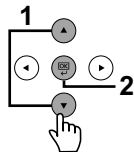

> Privado/Guardado  
? User 01

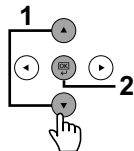

> User 01  
? Data 01

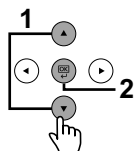

> Data 01  
ID 0000

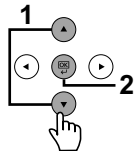

> Data 01  
Copias 000

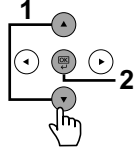

FI

Työlokero >

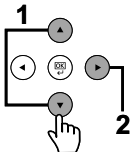

> Yksityin/tallennettu

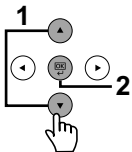

> Yksityin/tallennettu  
? User 01

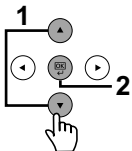

> User 01  
? Data 01

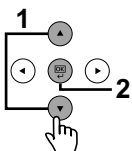

> Data 01  
Tunnus 0000

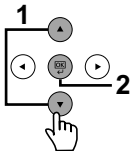

> Data 01  
Kopioita 000

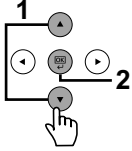

FR

Boîte travail >

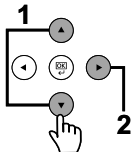

> Privé/Stocké

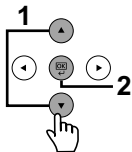

> Privé/Stocké  
? User 01

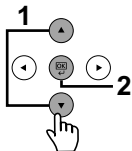

> User 01  
? Data 01

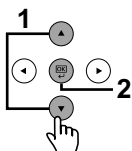

> Data 01  
ID 0000

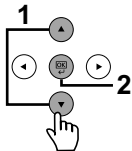

> Data 01  
Nb copies 000

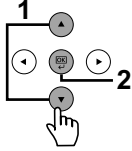

HU

Feladatlapok >

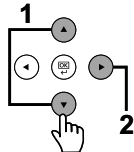

> Privát/Tárolt

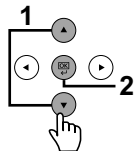

> Privát/Tárolt  
? User 01

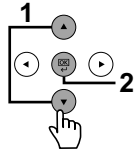

> User 01  
? Data 01

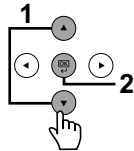

> Data 01  
AZ 0000

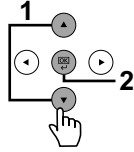

> Data 01  
Másolatok 000

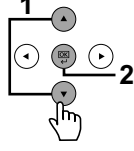

IT

Casella job >

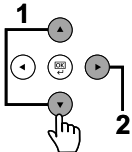

> Privato/Salvato

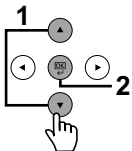

> Privato/Salvato  
? User 01

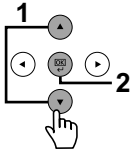

> User 01  
? Data 01

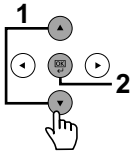

> Data 01  
ID 0000

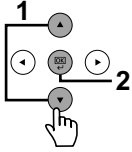

> Data 01  
Copie 000

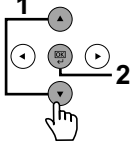

NL

Taakbox >

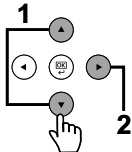

> Privé/Opgeslagen

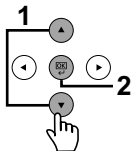

> Privé/Opgeslagen  
? User 01

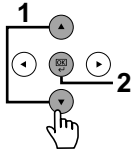

> User 01  
? Data 01

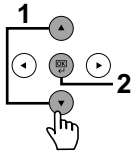

> Data 01  
ID 0000

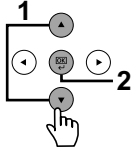

> Data 01  
Exemplaren 000

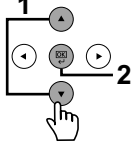

NO

Jobb-boks >

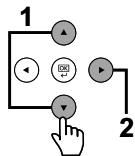

> Privat/Lagret

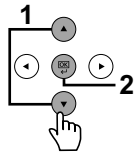

> Privat/Lagret  
? User 01

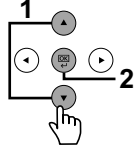

> User 01  
? Data 01

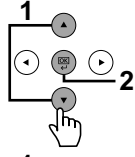

> Data 01  
ID 0000

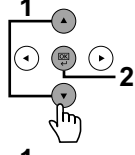

> Data 01  
Eksemplarer 000

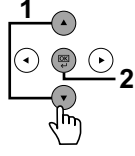

PL

Pojemnik na zadania >

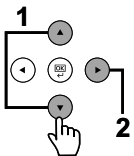

> Prywatne/Przechowyw.

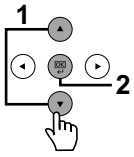

> Prywatne/Przechowyw.  
? User 01

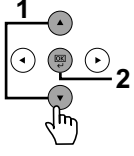

> User 01  
? Data 01

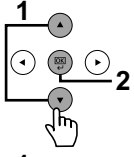

> Data 01  
ID 0000

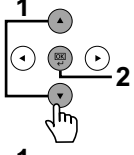

> Data 01  
Ilość kopii 000

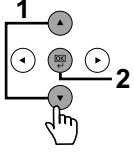

PT-BR

Caixa Trabalho >

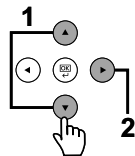

> Privado/armazenado

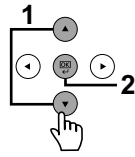

> Privado/armazenado  
? User 01

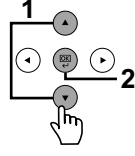

> User 01  
? Data 01

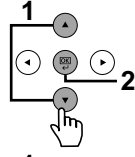

> Data 01  
ID 0000

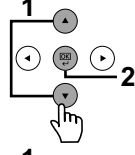

> Data 01  
Cópias 000

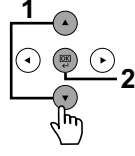

PT-PT

Caixa de trabalhos >

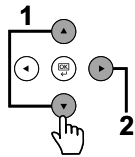

> Privado/armazenado

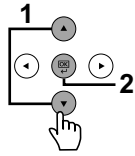

> Privado/armazenado  
? User 01

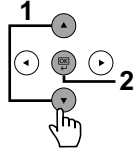

> User 01  
? Data 01

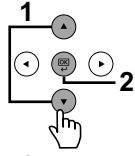

> Data 01  
ID 0000

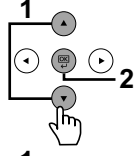

> Data 01  
Cópias 000

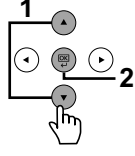

RO

Casetă lucrare >

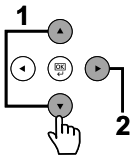

> Privat/Stocat

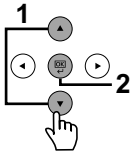

> Privat/Stocat  
? User 01

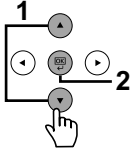

> User 01  
? Data 01

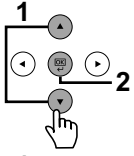

> Data 01  
ID 0000

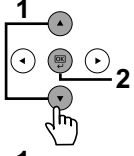

> Data 01  
Copii 000

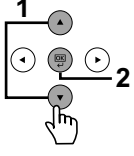

RU

ЯЩИК ЗАДАНИЙ >

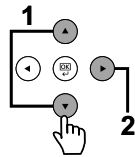

> ЛИЧНАЯ/СОХР.

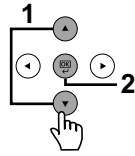

> ЛИЧНАЯ/СОХР.  
? User 01

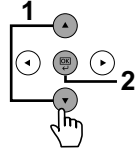

> User 01  
? Data 01

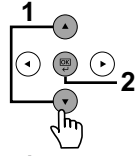

> Data 01  
ID 0000

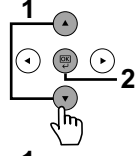

> Data 01  
КОПИИ 000

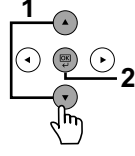

SV

Jobblåda >

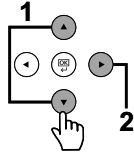

> Privat/Lagrad

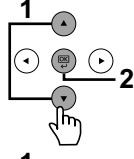

> Privat/Lagrad  
? User 01

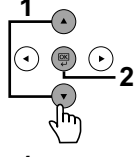

> User 01  
? Data 01

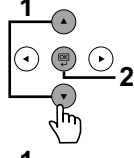

> Data 01  
ID 0000

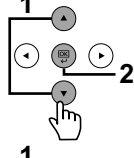

> Data 01  
Kopior 000

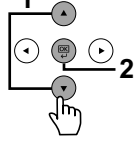

TR

İş Kutusu >

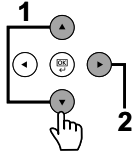

> Özel/Kayıtlı

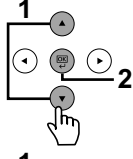

> Özel/Kayıtlı  
? User 01

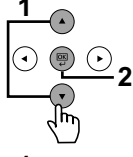

> User 01  
? Data 01

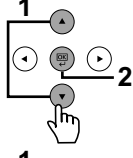

> Data 01  
ID 0000

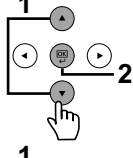

> Data 01  
Kopyalar 000

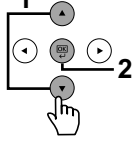

AR

صندوق المهام >

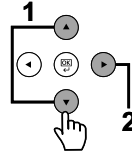

> خاص/محفوظ

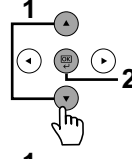

> خاص/محفوظ  
? User 01

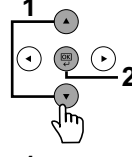

> User 01  
? Data 01

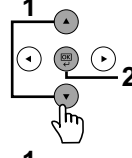

> Data 01  
ID 0000

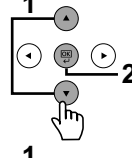

> Data 01  
النسخ 000

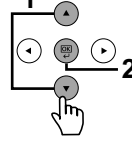



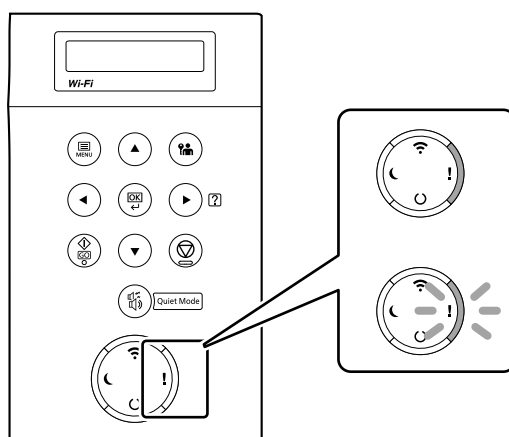

- EN** If an error occurs on the machine, the error message appears on the screen. Also the Attention indicator on the operation panel will light up or flash. Refer to the Operation Guide to Clear the error. For details, refer to the Operation Guide on the Product Library disc.
- CA** Si es produeix un error en el dispositiu, es mostrarà el missatge d'error a la pantalla. També s'il·luminarà o parpellejarà l'indicador "Attention" (Alerta) al tauler d'operacions. Consulteu la Guia de funcionament per esborrar l'error. Per obtenir més informació, consulteu la Manual d'instruccions al disc Biblioteca del producte.
- CS** Pokud v zařízení dojde k chybě, na obrazovce se objeví chybové hlášení. Indikátor Attention na ovládacím panelu se rozsvítí nebo bude blikat. Pro odstranění chyby se řiďte návodem k obsluze na disku Product Library.
- DA** Hvis der opstår fejl på maskinen, vises fejlmeddelelsen på skærmen. Samtidig vil Attention-lampen på betjeningspanelet lyse eller blinke. Se betjeningsguiden for at slette fejlen. Se Betjeningsvejledning på Product Library disken for yderligere information.
- DE** Falls ein Gerätefehler auftritt, erscheint eine Fehlermeldung in der Anzeige. Außerdem leuchtet oder blinkt die LED "Warnung" auf dem Bedienfeld. Lesen Sie in der Bedienungsanleitung nach, um den Fehler zu beseitigen. Weitere Details finden Sie in der Bedienungsanleitung auf dem Product Library Datenträger.
- EL** Αν πραγματοποιηθεί σφάλμα στο μηχάνημα, το μήνυμα του σφάλματος εμφανίζεται στην οθόνη. Επίσης, η ενδεικτική λυχνία Attention στον Πίνακα Λειτουργίας θα ανάψει ή θα αναβοσβήσει. Ανατρέξτε στο Εγχειρίδιο Χρήσης για να διορθώσετε το σφάλμα. Για λεπτομέρειες, ανατρέξτε στο Εγχειρίδιο Χρήσης στον δίσκο Product Library.
- ES** Si se produce un error en la máquina, el mensaje de error aparecerá en la pantalla. Además, el indicador Atención del panel de controles se iluminará o parpadeará. Consulte la Guía de uso para borrar el error. Para obtener más información, consulte la Guía de uso que está disponible en el disco Product Library.
- FI** Jos koneessa on vikatila, ruudulle ilmestyy vikailmoitus. Myös toimintapaneelin Attention -indikaattori syttyy tai vilkkuu. Katso Toimintaoppaasta, kuinka vikatila poistetaan. Löydät yksityiskohtaiset tiedot Tuotekirjastolevyn Käyttöopas.
- FR** Si une erreur se produit sur la machine, le message d'erreur s'affiche sur l'écran. De plus, le voyant Attention s'allume ou clignote sur le panneau de commande. Se reporter au manuel d'utilisation pour effacer l'erreur. Pour plus de détails, se reporter au manuel d'utilisation sur le disque Product Library.
- HU** Ha hiba történik a készüléken, egy hibaüzenet jelenik meg a képernyőn. Emellett az Attention jelzőfény is világít vagy villog a kezelőpanelen. A hiba megszüntetéséhez lásd a használati útmutatót. Részletekért lásd a Product Library lemezen lévő Használati útmutatót.
- IT** Se sulla macchina si verifica un errore, sullo schermo viene visualizzato un messaggio di errore. Inoltre, l'indicatore Attenzione del pannello comandi si illumina oppure lampeggia. Per eliminare l'errore, consultare la Guida alle funzioni. Per i dettagli, vedere la Guida alle funzioni, reperibile sul disco Product Library.
- NL** Als er een fout optreedt op het apparaat, dan verschijnt de foutmelding op het scherm. Bovendien gaat ook het Opgelet-indicatorlampje op het bedieningspaneel branden of knipperen. Raadpleeg de Gebruikershandleiding om de fout te wissen. Voor meer informatie, raadpleeg de Gebruikershandleiding op de Product Library schijf.

- NO** Hvis det oppstår en feil på maskinen, vises feilmeldingen på skjermen. Også "Attention"-indikatoren på betjeningspanelet vil tennes eller begynne å blinke. Se brukerveiledningen for å fjerne feilen. For detaljer, se Operatørhåndbok i produktbiblioteket.
- PL** Jeżeli na urządzeniu wystąpi błąd, na wyświetlaczu zostanie wyświetlony komunikat o błędzie. Błąd jest sygnalizowany też zaświeceniem się lub miganie wskaźnika Attention na panelu operacyjnym. Aby skasować błąd, postępuj zgodnie z instrukcją obsługi. Więcej informacji można znaleźć w Podręcznik obsługi znajdującej się na dysku Product Library.
- PT-BR** Se ocorrer um erro na máquina, a mensagem de erro aparece na tela. Também o indicador Atenção no painel de operação vai acender ou piscar. Consulte o Guia de Operação para corrigir o erro. Para obter detalhes, consulte o Guia de Operação no disco Biblioteca do Produto.
- PT-PT** Se ocorrer um erro na máquina, a mensagem de erro surge no ecrã. Além disso, o indicador "Atenção" no painel de operações irá acender ou piscar. Consulte o Guia de Funcionamento para Limpar o erro. Para mais informações consulte o Guia de Uso no disco da Biblioteca de Produtos.
- RO** Dacă apare eroare la aparat, mesajul de eroare apare pe ecran. De asemenea, indicatorul Attention de pe panoul de operare se va lumina sau va clipi. Consultați Ghidul de Operare pentru a rezolva eroarea. Pentru detalii, consultați Ghid de operare de pe discul Product Library.
- RU** Если в работе аппарата произошла ошибка, на экране появится сообщение об ошибке. Также будет светиться или мигать индикатор Внимание на панели управления. По поводу сброса ошибки см. руководство по эксплуатации. Дополнительная информация приведена в Руководстве по эксплуатации на диске Product Library.
- SV** Om ett fel uppstår på maskinen, visas felmeddelandet på skärmen. Även "Attention"-indikatorn på kontrollpanelen tänds eller blinkar. Hänvisning ges till användarmanualen för information om hur man tar bort felet. För ytterligare detaljer, konsultera Bruksanvisning som finns på skivan Product Library.
- TR** Makinede bir hata meydana gelirse, hata mesajı ekranda görüntülenir. Ayrıca çalıştırma panelindeki Attention göstergesi yanıp söner veya yanık kalır. Hatayı temizlemek için Çalıştırma Kılavuzuna bakın. Ayrıntılar için, Product Library DVD'sindeki Çalıştırma Kılavuzuna bakınız.
- AR** في حالة حدوث خطأ في الجهاز، تظهر رسالة الخطأ على الشاشة، وكذلك يضيء مؤشر Attention على لوحة التشغيل أو يومض. راجع دليل التشغيل للتخلص من الخطأ. للحصول على تفاصيل، راجع دليل التشغيل على قرص Product Library.

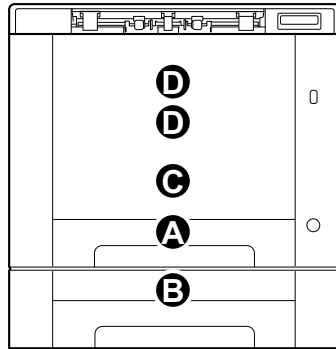
**A**

①

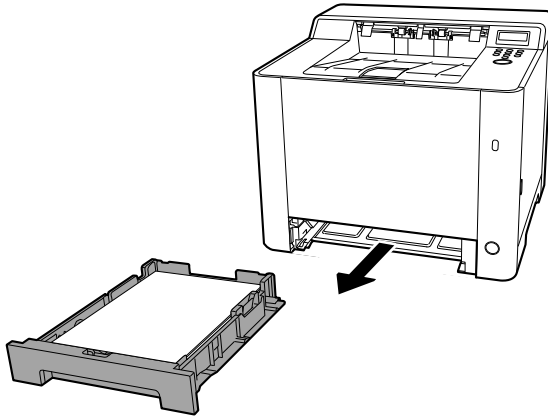

②

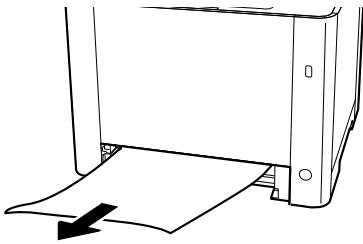

③

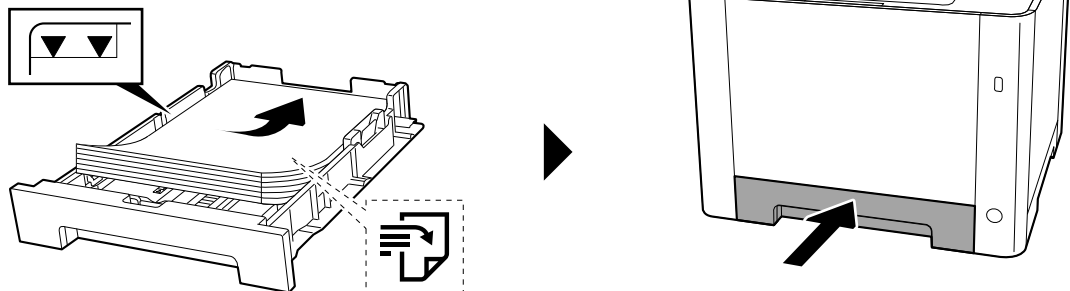

**B**

①

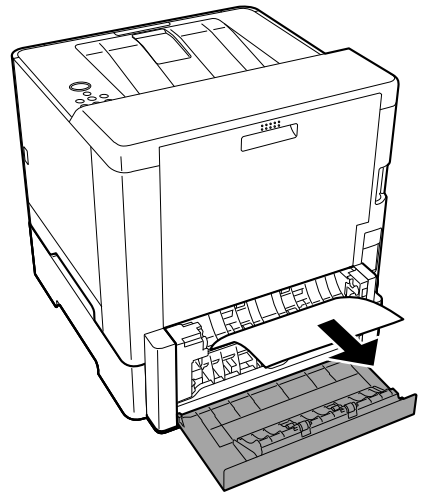
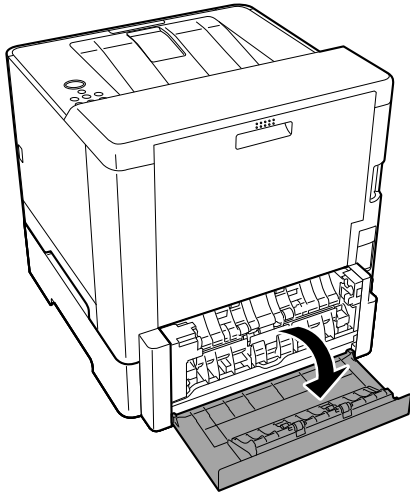

②

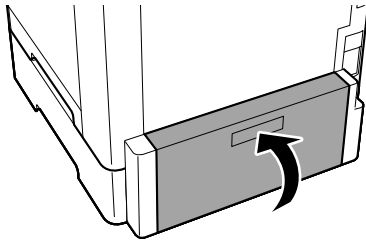

③

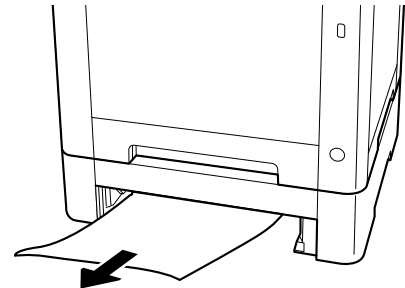
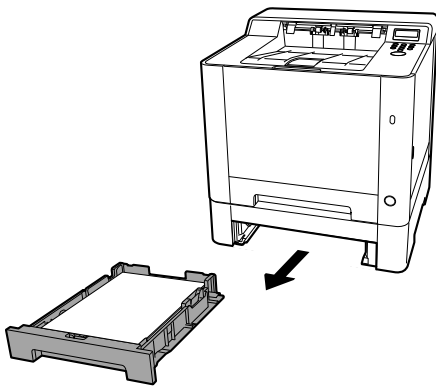

④

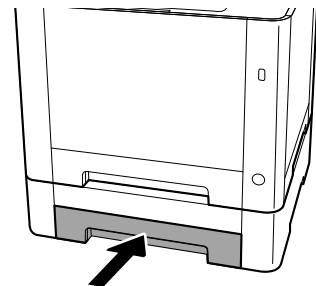
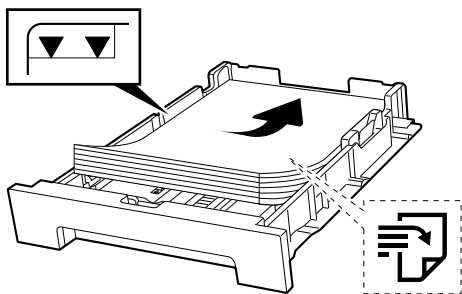

**C**

①

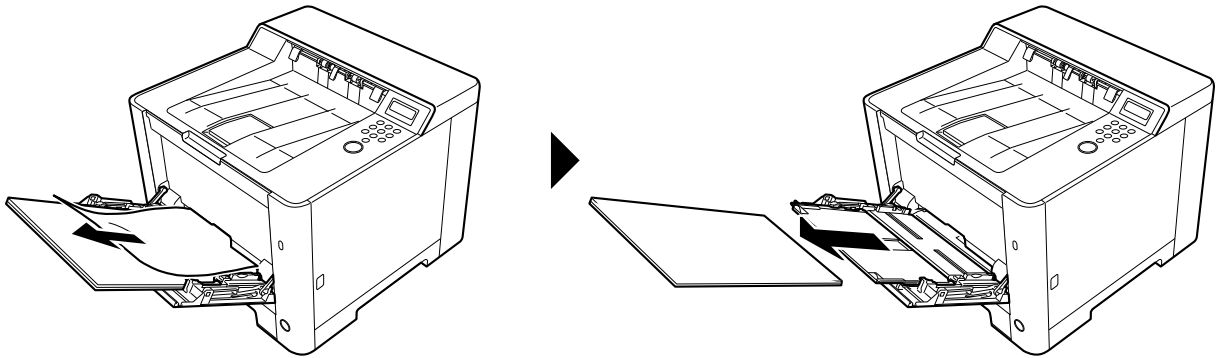

②

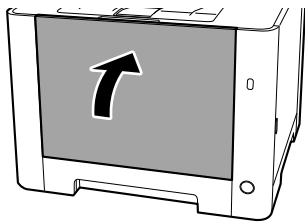

③

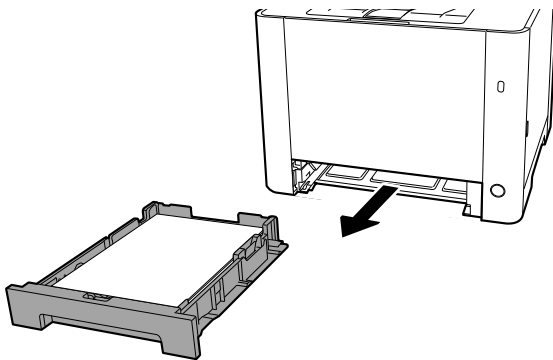

④

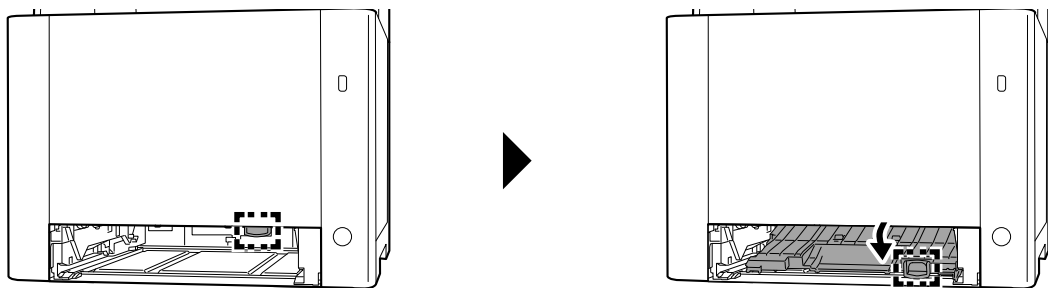

5

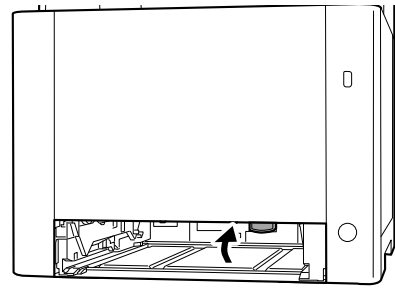
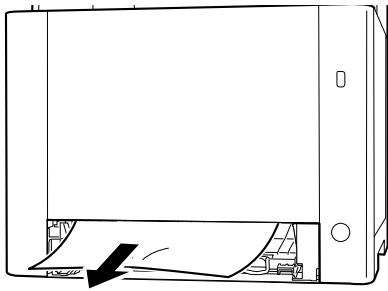

6

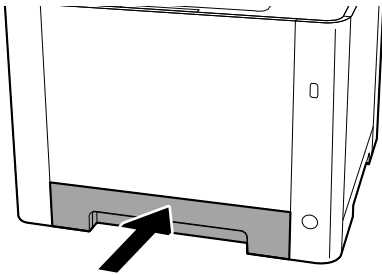

7

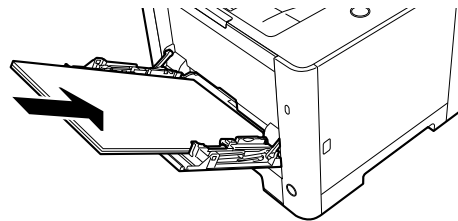
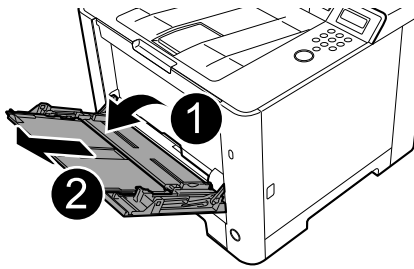

**D**

①

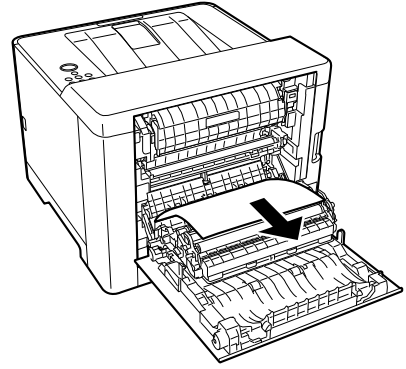
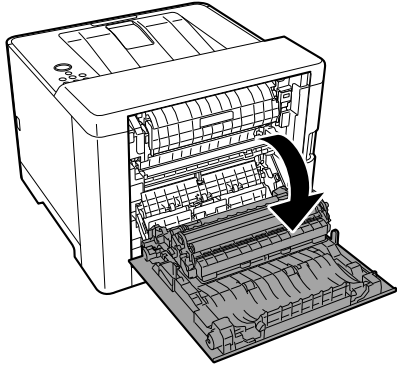

②

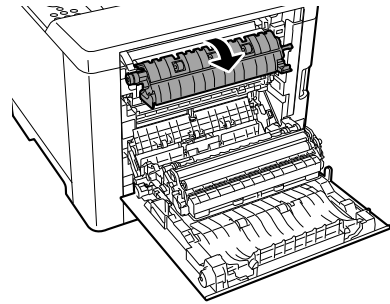
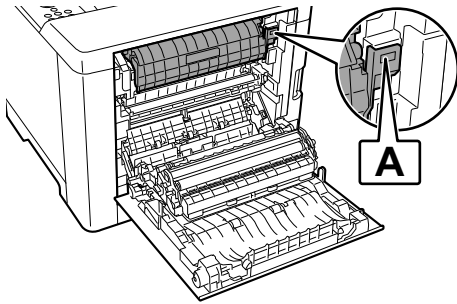

③

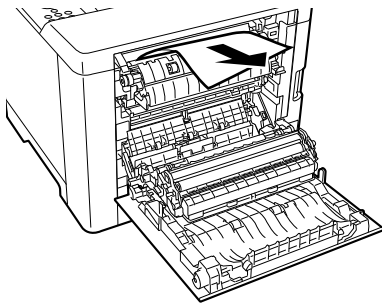

④

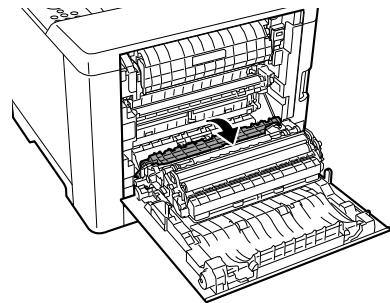
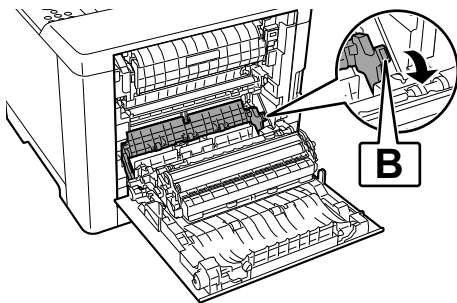

5

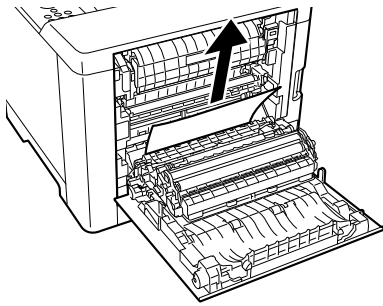

6

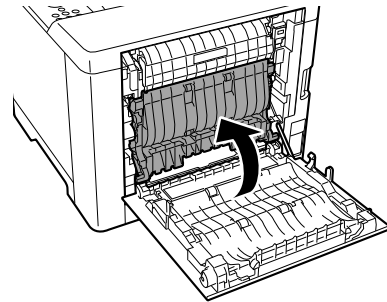
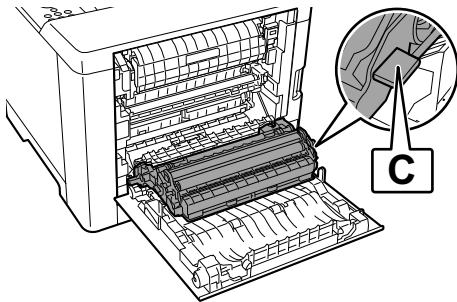

7

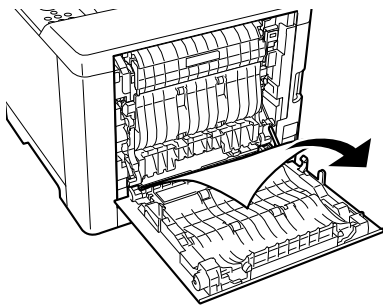

8

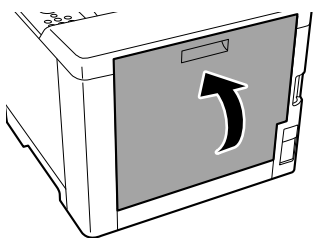



MEMO

MEMO

MEMO



**QUALITY  
CERTIFICATE**

This machine has passed  
all quality controls and  
final inspection.

